

## High-speed, High-accuracy CCD Laser Displacement Sensor

# LK-G Series

## User's Manual

Read this manual before using the system in order to achieve maximum performance.

Keep this manual in a safe place for future reference.



---

# Introduction

This Instruction Manual describes the basic operations and hardware functions of the LK-G Series. Read this manual carefully to ensure the optimum performance and full function of the LK-G Series before use.

Keep this manual in a safe place for future reference.

Be sure that the person who will finally operate this product receives this manual.

## ■ Symbols

These symbols alert you to matters concerning the prevention of human injury and product damage.

### **DANGER**

Failure to follow the instructions may lead to death or serious injury.

### **WARNING**

Failure to follow the instructions may lead to injury.

### **CAUTION**

Failure to follow the instructions may lead to product damage or failure of the product.

### **Note**

Provides additional information on proper operations that can be easily mistaken.

### **Reference**

Provides advanced and useful information for operation.

---

# Safety Precautions

## General Cautions

- At startup and during operation, be sure to monitor the functions and performance of the LK-G Series.
- We recommend that you take substantial safety measures to avoid any damage in the event of a problem occurring.
- Do not attempt to open or modify the LK-G Series or use it in any way other than as described in the specifications. If the LK-G Series is modified or used other than as described, the warranty will be voided.
- When the LK-G Series is used in combination with other devices, functions and performance may be degraded, depending on the operating conditions and surrounding environment.
- Do not use the LK-G Series for the purpose of protecting the human body.
- Do not allow the temperature to change sharply around the LK-G Series, including the accessories. Otherwise, condensation may lead to malfunction.

## WARNING

### Follow the safety precautions below to ensure safe operation

- Apply the correct power voltage. Failure to do so may cause fire, electric shock, or malfunction.
- Do not attempt to disassemble or modify the unit. Doing so may cause fire or electric shock.

### Handling abnormalities

Turn off the power immediately in the following cases. Using the unit in an abnormal condition could cause fire, electric shock, or accident.

Contact the nearest KEYENCE office for repair.

- If liquid including water, chemicals or debris enters the unit.
- If the unit is dropped or the case is damaged.
- If abnormal smoke or odor is present.

---

## CAUTION

### Follow the safety precautions below to ensure safe operation

- Be sure to turn the power off when you plug/unplug the cable that leads to the unit and its accessories. Not following this caution may result in damage.
- Do not turn off the power while setting items. The data being set or all the data may be lost.
- Do not block the vent holes on the unit. Increase of internal temperature may cause failure.

### Installation environment

To use the LK-G Series correctly and safely, avoid installing it in the following locations; doing so may lead to breakdown of the unit.

- Location that is humid, dusty or poorly ventilated
- Location with a high temperature such as a place exposed to direct sunlight
- Location where there are flammable or corrosive gases
- Location where the unit may be directly subjected to vibration or impact
- Location where water, oil or chemicals may splash onto the unit
- Location where static electricity is easily generated

### Corrective action for noise

Do not install the LK-G Series near a power source or high-voltage cable, otherwise noise may cause the LK-G Series to malfunction. Take corrective action for noise by using noise filters, laying cables separately, and/or installing insulation on the controller and the measuring unit. Use the single core shielded cable for the analog output cable.

### Influence of ambient temperature

A change in the ambient temperature may cause the measurement to fluctuate. Be sure to keep it stabilized. When the ambient temperature changes by 10 °C, it takes 60 minutes for the distribution of internal temperature to equalize.

### Operating ambient light intensity level

Do not use the LK-G Series near a lighting system that repeatedly and rapidly turns on and off. If it is unavoidable to use the unit in such a place, install a light shielding board or the like so that the light will not affect the measurement.

### Warming up

Before using the LK-G Series, wait approximately 30 minutes after the power is turned on. Otherwise, the measured value may gradually fluctuate because the circuit is not immediately stable after the power is turned on.

---

## **Influence of dust or dirt**

The measurement may fluctuate due to dirt, dust or fluid such as water or oil in the following cases:

- Adhesion on the protection glass: Blow the dirt off with clean air. If dirt persists, wipe the glass surface gently using a soft cloth moistened with alcohol.
- Adhesion on the surface of the measuring target: Blow the dirt off with clean air or wipe it off.
- Intrusion of floating or sprinkled dust or dirt into the light-axis range: In this case, take corrective action with a protective cover or air purge.

## **Notes**

### **Influence of vibration**

When the measuring target is vibrating, the measured value may fluctuate. In this case, increase the average number of times of measurement to achieve a more accurate value.

### **Measuring target**

The measured value may fluctuate if the shapes or surfaces of the measuring targets vary. In this case, use a known target and perform appropriate correction using the calibration function.

### **Handling**

Do not wipe with a wet cloth, benzene, or thinner. Doing so may change the color or shape of the unit. If the unit has much dirt on it, wipe it off with a cloth moistened with a mild detergent, then wipe with a soft dry cloth.

### **Effect of atmospheric motions**

Slow atmospheric motions may affect the measurement and result in fluctuation of the measured value. In such a case, take the following countermeasures.

- Enclose the measurement portion with an appropriate enclosure.
- Agitate the air between the measurement portion and the workpiece more strongly with a fan.

## **Precautions on CE Marking**

The LK-G Series conforms to the EMC Directive subject to the conditions that the following requirements are satisfied. In order to use this equipment in the EU countries, be sure that the following requirements have already been satisfied beforehand.

The applicable standards are explained below.

EMI: EN61326, class A

EMS: EN61326

Length of the power cord that is connected to the Controller, and length of all input/output cords must be limited to shorter than 30 m.

## Safety Precautions on Laser Products

The models of the LK-G Series are classified in terms of laser class as follows:

Model		LK-G35/LK-G30 LK-G155/LK-G150	LK-G37/LK-G32 LK-G157/LK-G152	LK-G15/LK-G10
Wavelength		650 nm		
FDA (CDRH) Part 1040.10	Maximum output	4.8 mW	0.95 mW	0.3 mW
	Class	Class III a	Class II	Class II
IEC60825-1: 1993 + A1: 1997 + A2: 2001	Maximum output	4.8 mW	0.95 mW	0.3 mW
	Class	Class 3R	Class 2	Class 1*
JIS C6802: 1997	Maximum output	4.8 mW	0.95 mW	0.3 mW
	Class	Class 3A	Class 2	Class 1

\*LK-G15/LK-G10 is a class 1 laser product according to IEC60825-1.

### WARNING

Use of controls or adjustments or performance of procedures other than those specified herein may result in hazardous radiation exposure.

### Cautions on class III a/3R/3A laser products

Observe the following instructions. Otherwise, injury to the human body (eyes and skin) may result.

- Do not direct the laser beam at other persons.
- Never look at the laser beam through optical instruments such as a microscope, magnifier or telescope.
- Make the laser path as short as possible and be sure to terminate the laser path with a diffusion reflector or diffusion absorber so that the laser beam does not diffuse. (It is recommended to install the protection enclosure.)
- Install the laser product so that the laser beam be located well above or below eye level.
- Install the laser product carefully so that the laser beam is not unintentionally directed at mirror- like surfaces.
- It is recommended to wear protective eye goggles.
- Do not disassemble the LK-G Series.
- Do not look directly at the laser beam.

---

**Cautions on Class II/2 laser products**

Observe the following instructions. Otherwise, injury to the human body (eyes and skin) may result.

- Do not direct the laser beam at other persons.
- Do not disassemble the LK-G Series.
- Do not stare at the laser beam.

**Cautions on Class 1 laser products**

- Do not look directly at the laser beam for an extended period of time.
- Do not disassemble the LK-G Series.

The LK-G Series is equipped with the following safety features based on IEC60825-1 and CDRH Part 1040.10 (Safety of laser products).

■ **Laser radiation emission warning indicator**

Lights or flashes while the LK-G Series is in operation.

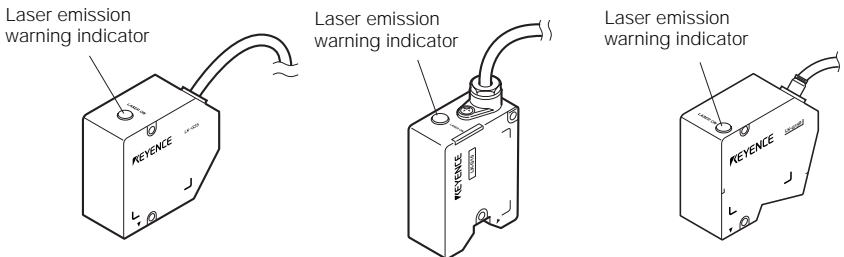

■ **Laser remote interlock connector**

The laser beam stops radiation emission upon opening the circuit between the REMOTE terminal and the COM IN terminal.

📖 Refer to "12-pin I/O terminal block" (page 4-2) for connecting terminals.

■ **Beam stop or attenuator**

The laser beam stops radiation emission by the following operations :

- NPN type: Short-circuiting between the LASER OFF terminal and COM IN terminal.
- PNP type: Apply the voltage between the LASER OFF terminal and COM IN terminal.

📖 Refer to "Expansion Connector" (page 4-5) for connecting terminals.

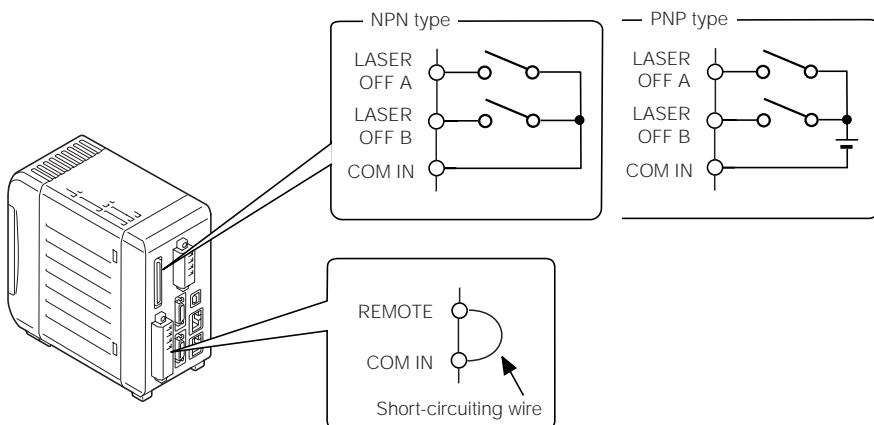

\* The laser remote interlock connector is delivered with the wire for short-circuiting installed.



## ■ Warning labels

The contents of warning indications and locations for attaching warning labels are described below.

The FDA (CDRH) warning labels are attached to the unit when shipped from the factory. Labels other than the FDA (CDRH) label are supplied with the unit. Attach the other label(s) to the locations as shown in the figure on page 9 according to the destinations of the product.

Warning label are not supplied with LK-G15/LK-G10, because these models are IEC class 1 and JIS class 1 products.

## ■ Label contents

### ● LK-G35/LK-G30/LK-G155/LK-G150

FDA (CDRH)

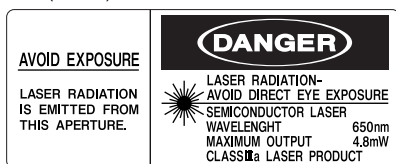

IEC (English)

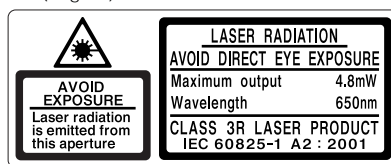

IEC (German)



IEC (French)



JIS (Japanese)

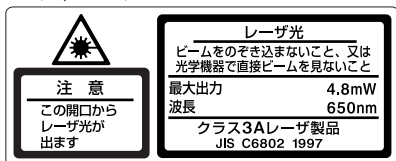

GB (Simplified Chinese)

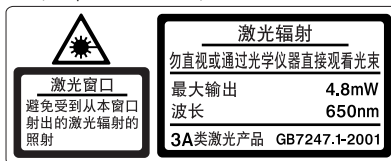

● LK-G37/LK-G32/LK-G157/LK-G152

FDA (CDRH)

<p><b>AVOID EXPOSURE</b></p> <p>LASER RADIATION IS EMITTED FROM THIS APERTURE.</p>		<p><b>CAUTION</b></p> <p>LASER RADIATION- DO NOT STARE INTO BEAM</p> <p>SEMICONDUCTOR LASER WAVELENGTH 650nm MAXIMUM OUTPUT 0.95mW CLASSII LASER PRODUCT</p>
--	---	--

IEC (English)

	<p><b>LASER RADIATION</b></p> <p><b>DO NOT STARE INTO BEAM</b></p> <p>Maximum output 0.95mW Wavelength 650nm <b>CLASS 2 LASER PRODUCT</b> IEC/EN 60825-1 A2 : 2001</p>
---	--

IEC (German)

	<p><b>LASER-STRAHLUNG</b></p> <p><b>NICHT IN DEN STRAHL BLICKEN!</b></p> <p>Maximum Leistung 0.95mW Wellenlänge 650nm <b>LASER KLASSE 2</b> DIN EN 60825-1 A2 : 2001</p>
---	--

IEC (French)

	<p><b>RAYONNEMENT LASER</b></p> <p><b>NE PAS REGARDER DANS LE FAISCEAU</b></p> <p>Puissance émise max. 0.95mW Longueur d'onde 650nm <b>APPAREIL À LASER DE CLASSE 2</b> IEC/EN 60825-1 A2 : 2001</p>
---	--

JIS (Japanese)

	<p><b>レーザー光</b></p> <p><b>ビームをのぞき込まないこと</b></p> <p>最大出力 0.95mW 波長 650nm <b>クラス2 レーザ製品</b> JIS C6802 1997</p>
---	--

GB (Simplified Chinese)

	<p><b>激光辐射</b></p> <p><b>勿直视光束</b></p> <p>最大输出 0.95mW 波长 650nm <b>2类激光产品</b> GB7247.1-2001</p>
---	--

● LK-G15/LK-G10

FDA (CDRH)

<p><b>AVOID EXPOSURE</b></p> <p>LASER RADIATION IS EMITTED FROM THIS APERTURE.</p>		<p><b>CAUTION</b></p> <p>LASER RADIATION- DO NOT STARE INTO BEAM</p> <p>SEMICONDUCTOR LASER WAVELENGTH 650nm MAXIMUM OUTPUT 0.3mW CLASSII LASER PRODUCT</p>
--	---	---

■ Label attachment locations

● LK-G35/LK-G30/LK-G37/LK-G32

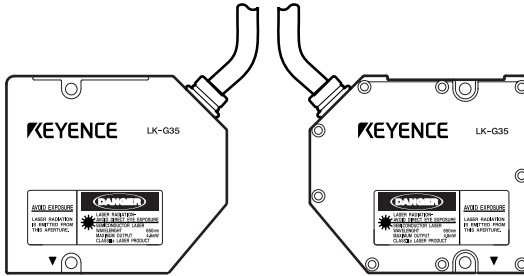

● LK-G155/LK-G150/LK-G157/LK-G152

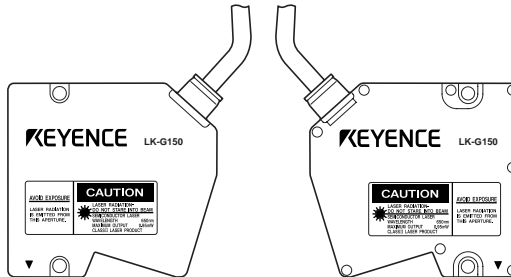

● LK-G15/LK-G10

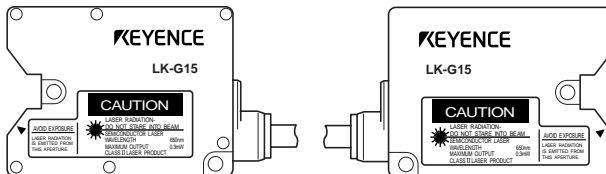

---

MEMO

---

# Organization of this Manual

Chapter <b>1</b>	Before Use	Describes cautions and preparations before use.
Chapter <b>2</b>	Operations and Functions during Measurement	Describes the operations that can be performed during displacement measurement and their functions.
Chapter <b>3</b>	Function Settings	Describes the functions and setting procedures of the Head settings, Output settings, Common settings, and Environment settings.
Chapter <b>4</b>	Input/Output Terminals	Describes the specifications of the input/output terminals and timing chart.
Chapter <b>5</b>	RS-232C	Describes the functions of the RS-232C interface and the setting procedures.
Chapter <b>6</b>	Specifications	Describes the specifications of the controller and the head, outside dimensions, and characteristics.
Appendices	Appendices	Describes the troubleshooting methods, contents of error messages and optional products.

<b>1</b>
<b>2</b>
<b>3</b>
<b>4</b>
<b>5</b>
<b>6</b>

---

# Table of Contents

Safety Precautions .....	1
General Cautions .....	1
⚠ WARNING .....	1
⚠ CAUTION .....	2
Notes .....	3
Precautions on CE Marking .....	3
Safety Precautions on Laser Products .....	4
Organization of this Manual .....	11
Table of Contents .....	12

---

## Chapter 1 Before Use

System Configuration .....	1-2
Checking the Package Contents .....	1-3
LK-G3001V/LK-G3001VP (Single Unit Type Controller) .....	1-3
LK-G3001/LK-G3001P (Separate Type Controller) .....	1-3
LK-GD500 (Separate Type Controller) .....	1-4
LK-G35/LK-G30 (Head) .....	1-4
LK-G15/LK-G10 (Head) .....	1-4
LK-G155/LK-G150/LK-G157/LK-G152 (Head) ..	1-5
LK-GC2/GC5/GC10/GC30 .....	1-5
Identifying Part Names and Functions ..	1-6
Controller .....	1-6
Head .....	1-8
Installing and Connecting the Heads and Option ..	1-9
Installing the Head .....	1-9
Attaching the ND Filter (Option) ...	1-12
Installations Depending on the Measurement Target .....	1-13
Installing the Controller .....	1-14
Connection .....	1-19
Outline of Measurement and Settings ..	1-21
Switching Modes .....	1-21
Setting Mode .....	1-22
Returning the LK-Series to the Factory Default Settings .....	1-23

---

## Chapter 2 Operations and Functions during Measurement

Switching the Measurement Value Displays ...	2-2
Setting the Tolerance Comparator Value .....	2-3
The Function of the Tolerance Settings .....	2-3
Hysteresis .....	2-5
Setting the Display Value Instantaneously to Zero (Auto-Zero) .....	2-6
Program Function .....	2-8
Switching Program Nos. ....	2-9
Performing Statistical Computation with the Measurement Value .....	2-10

---

## Chapter 3 Function Settings

Measurement, Data Flow and Functions .....	3-2
Setting the Head .....	3-3
List of Functions and Function Nos. ....	3-3
List of Default Values and Setting Ranges .....	3-3
List of the Head Setting Screens .....	3-4
Setting ABLE .....	3-5
Setting the Measurement Mode According to the Measuring Target .....	3-7
Specifying the Process When Measurement is Not Possible (Alarm Process) .....	3-8
Automatically Teching the Adjustment Range of ABLE According to the Target .....	3-10
Setting the Mounting Mode .....	3-12
Setting the Conditions of the Measurement Value Output .....	3-13
List of Functions and Function Nos. ...	3-13
List of Default Values and Setting Ranges ..	3-15
List of the OUT Setting Screens .....	3-16
Calculating Between the Heads ...	3-18
Setting the Scaling for Measurement (Calibration) .....	3-20
Stabilizing the Measurement by Filtering ..	3-22
Using the Hold Function (Measurement Mode) ..	3-25
Setting the Trigger Condition .....	3-31

Measuring with Offset.....	3-32
Setting the Unit and the Minimum	
Display Unit .....	3-33
Scaling the Analog Output .....	3-34
Outputting the Analog Output Without Holding .....	3-36
Setting the Common Function .....	3-37
List of Functions and Function Nos.....	3-37
List of Default Values and Setting Ranges.....	3-37
List of the Common Function Setting Screens .....	3-38
Setting the Sampling Rate of	
Measurement Value.....	3-39
Setting the Mutual Interference	
Prevention Function.....	3-40
Setting the External Timing Input .....	3-41
Setting the Output Form of	
the Tolerance Comparator .....	3-42
Setting the Strobe Output Time .....	3-43
Accumulating the Measurement Value in	
the Memory (Data Storage Function) .....	3-44
Setting the Operations of the Equipment	
(Environment Settings) .....	3-46
List of Functions and Function Nos.....	3-46
List of Default Values and Setting Ranges.....	3-47
List of the Environment Setting Screens .....	3-48
Setting the Communication	
Specifications of the RS-232C.....	3-49
Setting the Program Switching Method .....	3-50
Copying/Initializing the Program .....	3-51
Preventing Erroneous Operation on	
the Panel (Panel Lock) .....	3-53
Reducing the Power Consumption	
(Eco Mode).....	3-54

---

## Chapter 4 Input/Output Terminals

Identifying Names and Functions of the	
Input/Output Terminals .....	4-2
Functions of the Input/Output Terminals .....	4-2
Functions of the Input and Output Signals .....	4-7
Timing Chart .....	4-12

---

## Chapter 5 RS-232C

Specifications .....	5-2
Pin Layout.....	5-2
Communication Specifications .....	5-2
Communication Performance and	
Communication Mode in the	
Measurement State .....	5-3
Overview of the Settings According to	
External Devices.....	5-3
Outputting Measurement Values and	
Changing Settings through Commands .....	5-4
Connecting the PC or PLC Link Unit .....	5-4
Mode Change Command .....	5-7
Measurement Control Command Format .....	5-8
Change Parameter Command .....	5-13
Check Parameter Command Format .....	5-20
Timing Chart .....	5-21
Outputting Measurement Values in	
External Synchronization .....	5-22
Environment Settings Parameters.....	5-22
Output.....	5-22
Timing Chart .....	5-23
Output Format .....	5-24
ASCII Code Table (Reference).....	5-24

---

## Chapter 6 Specifications of the LK-G Series

Specifications .....	6-2
Specifications of the Controller .....	6-2
Specifications of the Head .....	6-4
Specifications of the Head-to-Controller Cable .....	6-14
Status Table.....	6-14
Response Delay Time .....	6-16
Outside Dimensions .....	6-16
Characteristics .....	6-21
Spot Dimension .....	6-21
Mutual Interference .....	6-22

---

## Appendices

Troubleshooting .....	A-2
Error Messages.....	A-5
List of Optional Products .....	A-6
Index .....	A-8



---

# Before Use

# 1

This chapter describes the configuration of the LK-G Series, cautions and required preparation before use. Be sure to read this section thoroughly before using the LK-G Series.

System Configuration .....	1-2
Checking the Package Contents .....	1-3
Identifying Part Names and Functions .....	1-6
Installing and Connecting the Heads and Option .....	1-9
Outline of Measurement and Settings .....	1-21
Returning the LK-Series to the Factory Default Settings ....	1-23

# System Configuration

1

The LK-G Series can be used for various purposes in combination with commercially available devices.

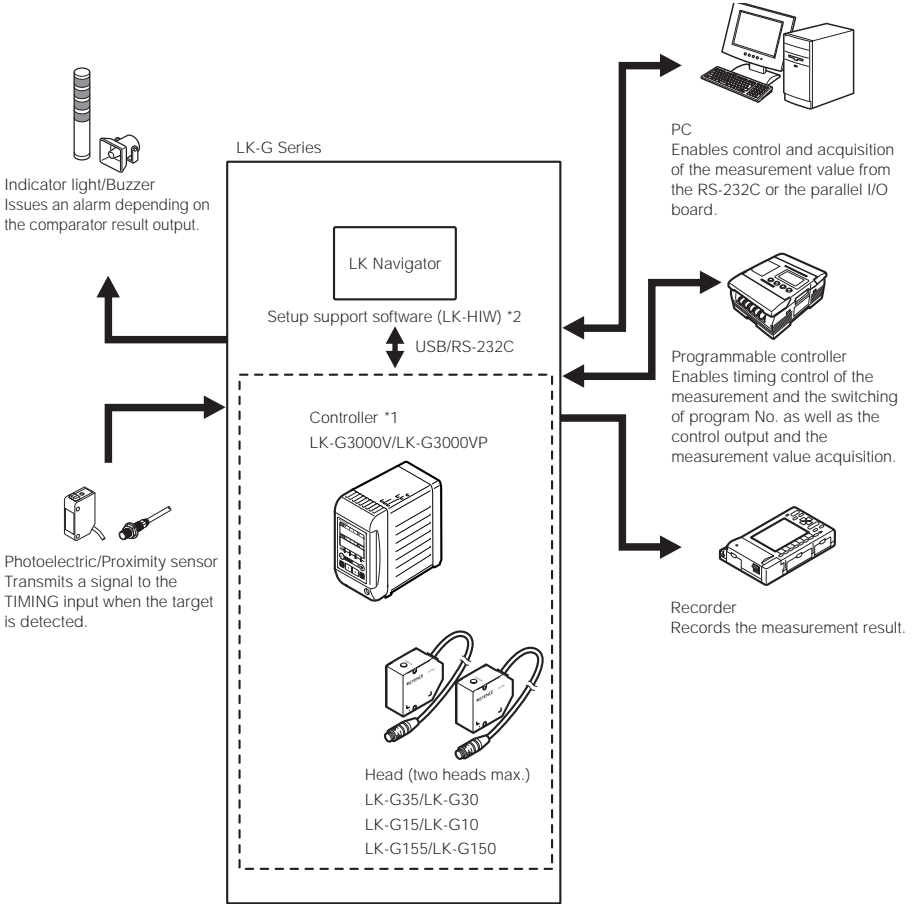

\*1: The controller (LK-G3001V/LK-G3001VP) can be separated into the display panel and the controller main unit. You can also purchase them separately.  
\*2: For the details of the setup support software (LK-H1W) "LK-Navigator", refer to "LK-Navigator User's Manual" (The PDF file stored in the CD-ROM).

# Checking the Package Contents

The LK-G Series consists of the following models. Check if the parts and equipment listed below are included in the package of the model you purchased before using the unit.

## LK-G3001V/LK-G3001VP (Single Unit Type Controller)

Controller  
LK-G3001V/  
LK-G3001VP: 1

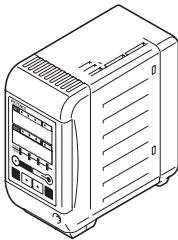

User's Manual  
(this manual): 1



Screwdriver  
: 1



Packed separately  
LK-H1W (CD-ROM)

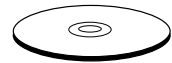

- Setup support software "LK-Navigator"
- Setup support software User's Manual (PDF file)

USB cable (3m)

## LK-G3001/LK-G3001P (Separate Type Controller)

Controller  
LK-G3001/  
LK-G3001P/: 1

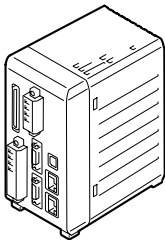

User's Manual  
(this manual): 1



Screwdriver



Packed separately  
LK-H1W (CD-ROM)



- Setup support software "LK-Navigator"
- Setup support software User's Manual (PDF file)

USB cable (3m)

## LK-GD500 (Separate Type Controller)

Display panel  
LK-GD500: 1

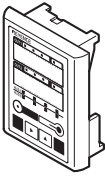

Panel attachment ring  
: 1

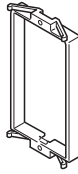

 The communication cable between the controller and the separate type display panel is sold separately. Refer to page A-6 for details.

## LK-G35/LK-G30 (Head)

Head: 1

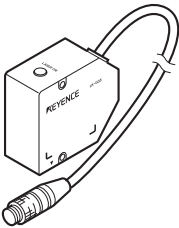

Laser sticker sheet: 1

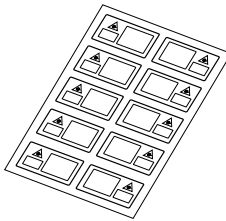

Cautions for export (A6): 1

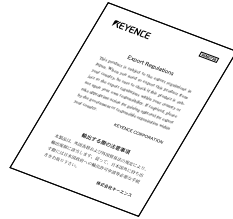

## LK-G15/LK-G10 (Head)

Head: 1

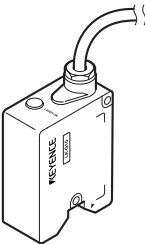

Cautions for export (A6): 1

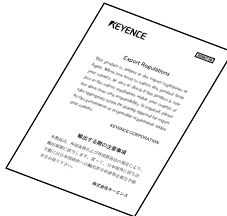

**LK-G155/LK-G150/LK-G157/LK-G152 (Head)**

Head: 1

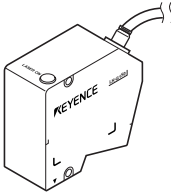

Laser sticker sheet: 1

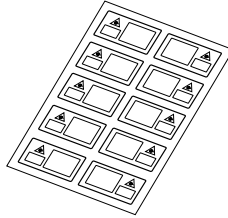

Cautions for export (A6): 1

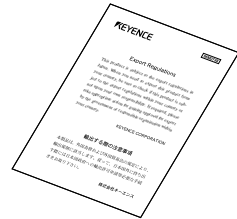
**LK-GC2/GC5/GC10/GC30**

Head-to-controller cable: 1



LK-GC2 : 2-m cable  
 LK-GC5 : 5-m cable  
 LK-GC10 : 10-m cable  
 LK-GC30 : 30-m cable

\* We have thoroughly inspected the package contents before shipment. However, in the event of defective or broken items, contact your nearest KEYENCE office (address listed in the end of this manual).

# Identifying Part Names and Functions

This section describes the name and function of each part.

## Controller

### Display panel

- 1 Display panel fixing case
- 2 Display panel fixing screw
- 3 Measurement value indicators  
Display the measurement value, tolerance comparator value, and various statistical results. The setting items are displayed during setting.  
Green: Within the tolerance Red: Outside the tolerance
- 4 Comparator output indicator  
Lights during the comparator output (HI, GO, or LO).
- 5 Timing input indicator  
Lights when the timing signal is being input.
- 6 Head status display indicator  
Displays the laser emission status and the measurement status.

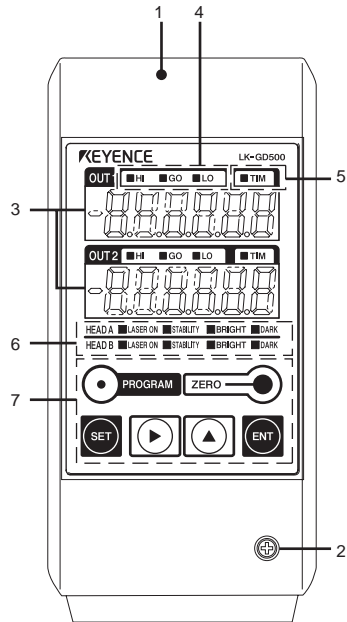







LASER ON	Laser emission LED. Lights while the LK-G Series is in operation.
STABILITY	Lights in green or orange within the measurement range. Lights in red outside the measurement range, alarm, or laser-off.
BRIGHT	Lights at the exceeding light intensity alarm.
DARK	Lights at the light intensity shortage alarm.

### 7 Operation keys

### Displays and descriptions of the measurement value indication

Display	Description
Numerical value ( $\pm 999999$ )	Displays the measurement result in numerical value. The display unit, decimal point position, and minimum display unit vary depending on the settings.
FFFFFF (HI output: ON. Monitor output: + 10.8 V)	Displayed when the value exceeds the display range.
-FFFFFF (LO output: ON. Monitor output: -10.8 V)	Displayed when the value drops below the display range.
- - - - - (HI, GO and LO outputs: OFF. Monitor output: -10.8 V)	Displayed during the comparator standby state.

## Operation keys

Key	Function
	<ul style="list-style-type: none"> <li>During measurement it calls the Program switch mode.</li> </ul>
	<ul style="list-style-type: none"> <li>During measurement it calls the Tolerance setting mode.</li> <li>When pressed for one second, it calls the Operation setting mode.</li> <li>During setting it cancels the setting content and returns to the previous setting.</li> </ul>
	<ul style="list-style-type: none"> <li>During measurement it calls the Statistics display mode.</li> <li>During setting it determines the content.</li> </ul>
	<ul style="list-style-type: none"> <li>During measurement it sets the measurement value to zero.</li> <li>When pressed for three seconds it cancels auto-zero.</li> <li>When pressed for three seconds while inputting the value, it initializes the selected item.</li> </ul>
	<ul style="list-style-type: none"> <li>During setting it switches the display to the next setting item.</li> <li>While inputting the value it shifts to one digit right.</li> <li>When pressed for one second or more it shifts in higher speed.</li> </ul>
	<ul style="list-style-type: none"> <li>During measurement it changes the display for OUT1, OUT2 or both at the same time.</li> <li>During setting it switches the setting content.</li> <li>While inputting the value it switches symbols or sets numerical values.</li> <li>When pressed for one second or more it shifts in higher speed.</li> </ul>

## Terminal panel

### 1 RS-232C connector

Establishes communication with a PC or a PLC.

 Refer to "Pin Layout" (page 5-2).

### 2 USB connector

Used when connecting the PC via USB.

Refer to "LK-Navigator User's Manual" for details.

### 3 6-pin terminal block

 Refer to "6-pin I/O terminal block" (page 4-4).

### 4 Expansion connector

 Refer to "Expansion connector" (page 4-5).

### 5 Head connectors

### 6 Laser emission LED.

Lights while the LK-G series operates.

### 7 Display panel connector

Connects the communication cable between the display panel and the controller.

### 8 12-pin terminal block

 Refer to "12-pin I/O terminal block" (page 4-2).

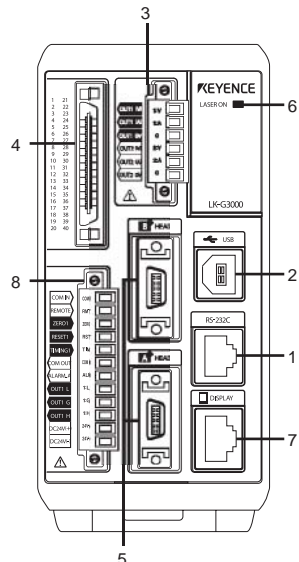

## Head

- 1 **Sensor (emitter)**  
Emits the laser beam for measurement. It is protected with a glass cover.
- 2 **Sensor (receiver)**  
Receives the laser beam for measurement. It is protected with a glass window.
- 3 **Attachment holes for the ND filter**  
Used for attaching the ND filter (LK-F1/ LK-F2).
- 4 **Installation holes**
- 5 **Connecting cable**  
Connected to the head-to-controller cable.
- 6 **Laser radiation emission LED**  
Lights or flashes while the LK-G Series is in operation.

Status	LED
Center of the measurement range	Lights in green
Within the measurement range	Lights in orange
Outside the measurement range Alarm Laser off	Flashes in orange

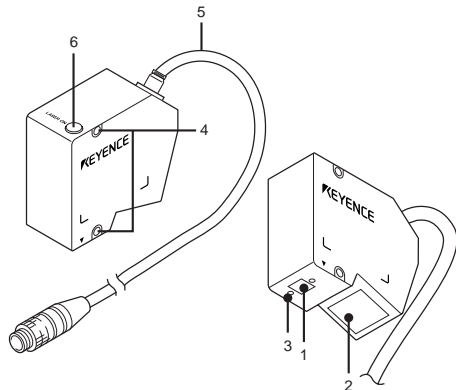
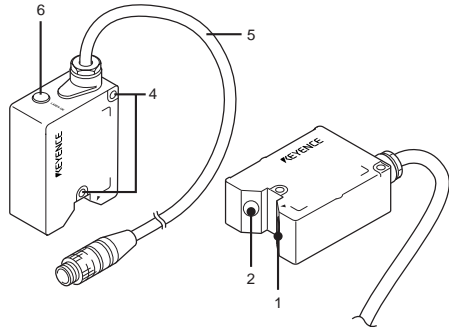
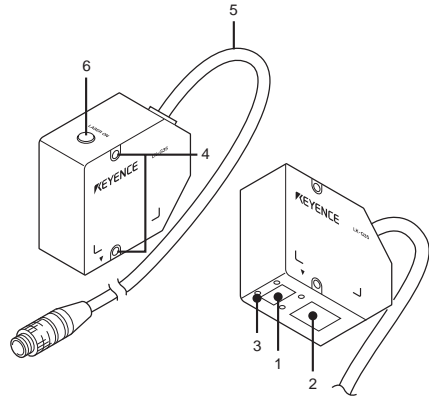



# Installing and Connecting the Heads and Option

## Installing the Head

1

Adjust the distance between the head and the measuring target, and fix the head with the screws at the two installation holes.

### ■ LK-G35/LK-G30/LK-G37/LK-G32

- Installation procedure

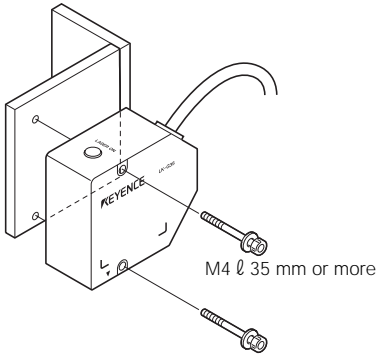

The measurement range is shown in the figure below.

- Diffuse reflection setup
- Regular reflection setup

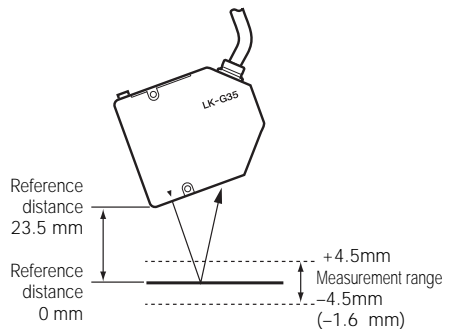
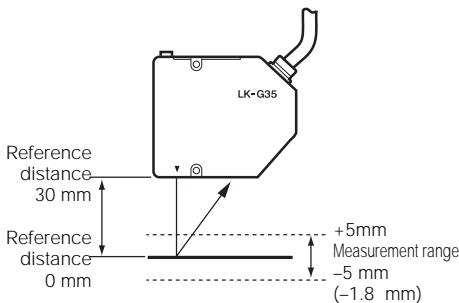

\* The value inside the parentheses ( ) is when the sampling rate is 20  $\mu$ s.

#### Reference

- The laser emission LED at both diffuse reflection and regular reflection lights in green within  $\pm 0.25$  mm of the reference position, and lights in orange in the other positions in the measurement range.

■ LK-G15/LK-G10

- Installation procedure

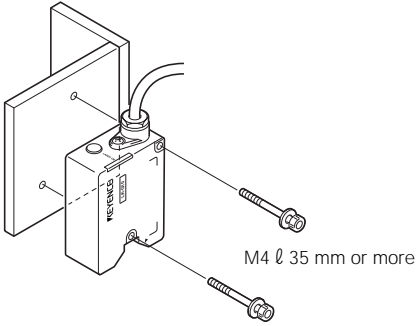

The measurement range is shown in the figure below.

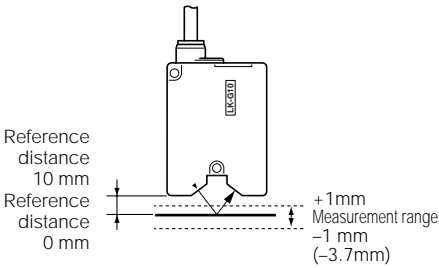

\* The value inside the parentheses ( ) is when the sampling rate is 20  $\mu$ s.

**Reference**

The laser emission LED at both diffuse reflection and regular reflection lights in green within  $\pm 0.05$  mm of the reference position, and lights in orange in the other positions in the measurement range.

## ■ LK-G155/LK-G150/LK-G157/LK-G152

- Installation procedure

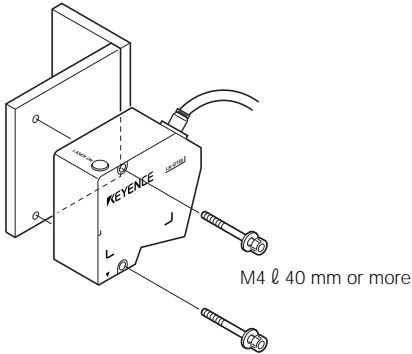

The measurement range is shown in the figure below.

- Diffuse reflection setup
- Regular reflection setup

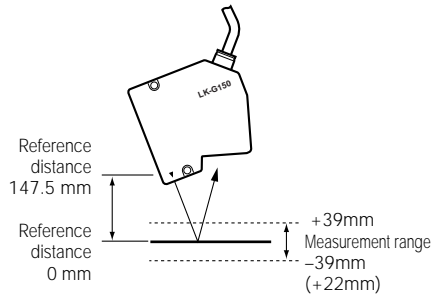
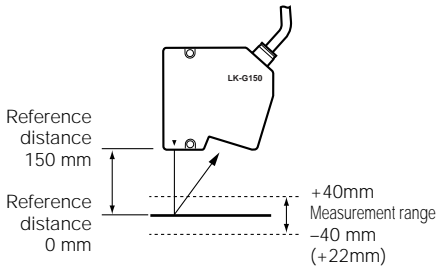

\* The value inside the parentheses ( ) is when the sampling rate is 20  $\mu$ s. Note that the measurement range narrows, disabling measurements at the reference position.

### Reference

- The laser emission LED at both diffuse reflection and regular reflection lights in green within  $\pm 2$  mm of the reference position, and lights in orange in the other positions in the measurement range.
- Select the mounting mode (☐ page 3-12) according to the installation conditions.

### ► Note

The measurement range when measuring a mirror surface or a glass surface at the time of regular reflection setup is between +39 (NEAR side) to -24 mm (FAR side). When the sampling rate is 20  $\mu$ s, the value becomes +39 (NEAR side) to +22 mm (NEAR side).

## Attaching the ND Filter (Option)

If the head is installed for regular reflection and the measurement target is a shiny mirror or glass surface, the measurement accuracy may deteriorate. In such a case, attach the ND filter (LK-F1) to ensure accurate measurement.

- LK-G35/LK-G30/LK-G37/LK-G32

- LK-G155/LK-G150/LK-G157/LK-G152

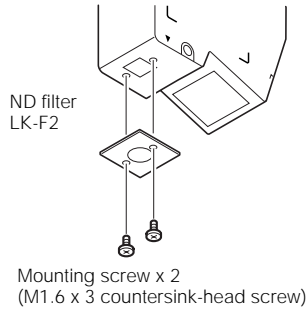
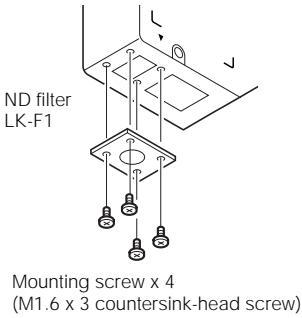

## Installations Depending on the Measurement Target

1

### Measuring distance

Use the head as close to the reference distance as possible. Doing so stabilizes the detection.

### Target shape

The installation of the head in the orientations indicated by the circle in the figures below is recommended.

### Near the wall surface

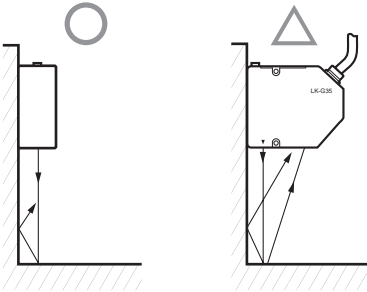

### Displacement in a hole

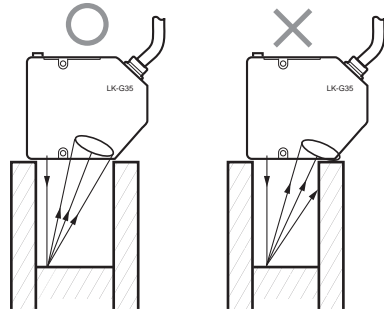

### Height-difference measurement

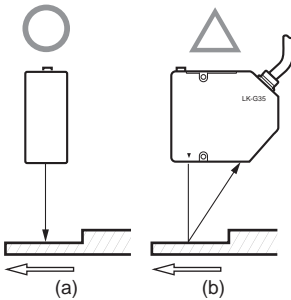

## Installing the Controller

Install the controller to the DIN rail, or fix it with screws.

1

### Caution on the installing orientation of the LK-G Series

Install the controller in the orientations shown in the following figures with a circle. Do not install it upside down.

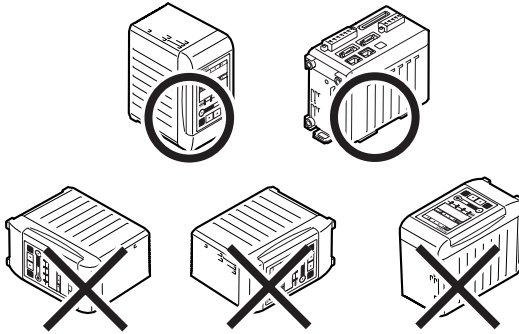

Be sure to leave 30 mm of clearance or more above the controller, and 10 mm or more on each side.

In addition, for ensuring the safe connection of the cord, leave 65 mm space or more in front of the terminal panel of the controller.

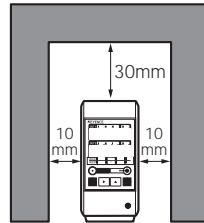

When installing the controllers side-by-side, make sure there is a clearance of 10 mm or more between the controllers and 30 mm or more of clearance above them.

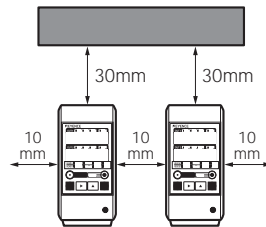

#### **CAUTION**

- Do not cover the ventilation holes on the top and the bottom of the controller. The heat stays inside causing a malfunction.
- When the temperature in the controller panel rises to over 50 °C, decrease the ambient temperature below 50 °C by introducing the forced cooling air or by securing more room around the system.

## Installing the LK-G3001V/LK-G3001VP (single unit type controller)

Install it on its bottom.

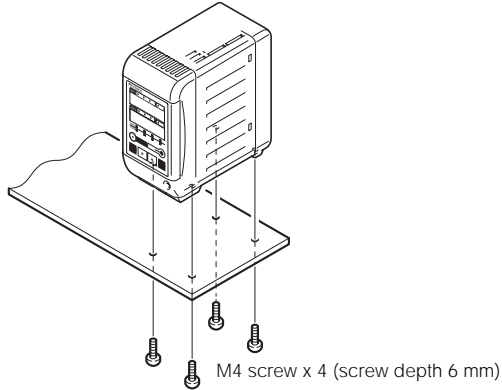

## Installing the LK-G3001/LK-G3001P and LK-GD500 (separate type controller)

Display panel (LK-GD500)

Controller (LK-G3001/LK-G3001P)

• Installing on a DIN rail

• Installing on its bottom

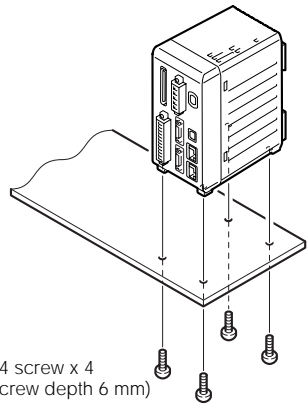
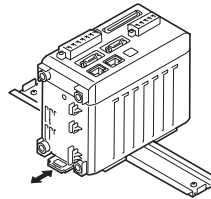
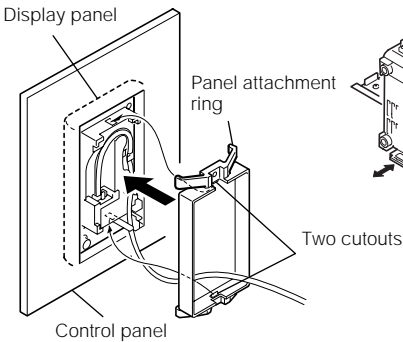

**Insert the display panel from the front, and fix it with the panel attachment ring.**

When removing the display panel, while pushing up the two cutouts of the attachment ring with a flat-head screwdriver, push out the display panel.

## Separating the single unit type controller

- 1 Disconnect the display panel cable from the display panel connector on the controller's terminal panel.**

Remove the display panel cable from the guide on the bottom of the controller.

- 2 Loosen the display panel fixing screw.**

### Reference

The display panel fixing screw does not drop from the display panel fixing case.

- 3 Remove the display panel fixing case from the controller.**

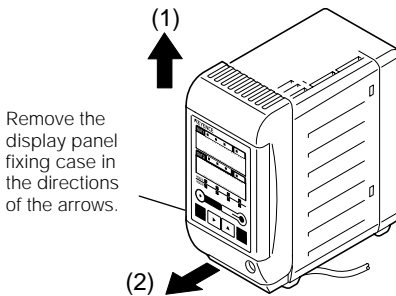

- 4 While pushing (1) and (2) outward in this order, push the display panel to remove the panel attachment ring.**

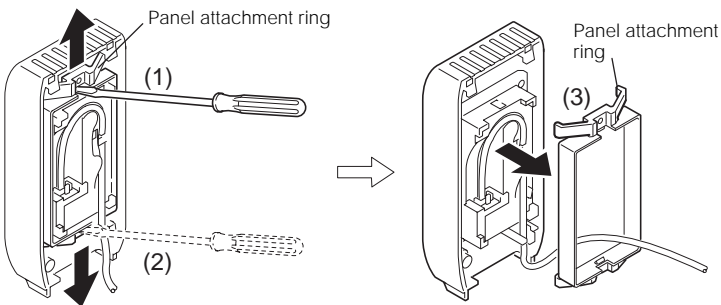

- 5 Remove the display panel from the display panel fixing case.**



## Combining the separate type controller

- 1** Install the display panel by aligning it with the two protrusions on the display panel fixing case.

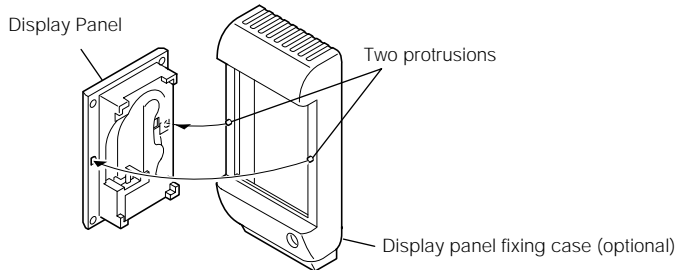

- 2** Fix the display panel with the panel attachment ring, and connect the 30-cm display cable (optional).

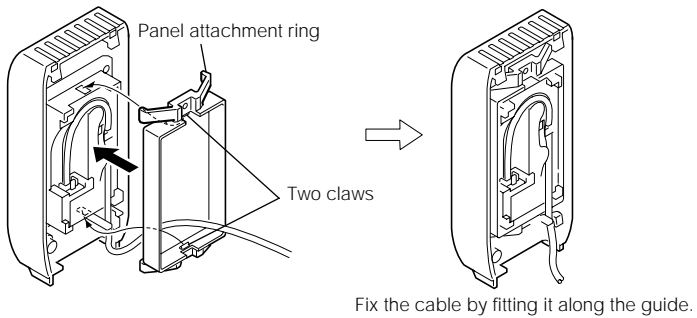

- 3** Align the three claws of the display panel fixing case with the controller.

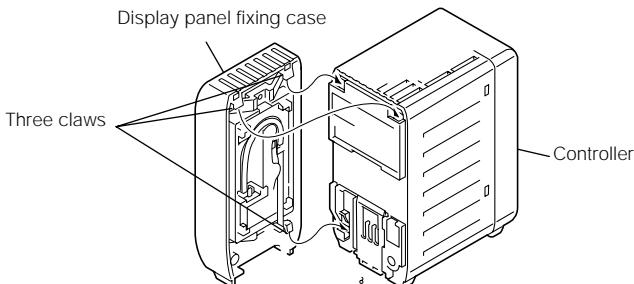

**4** Install the display panel fixing case along the groove on the controller.

Slide the front panel  
in the direction of the arrow.

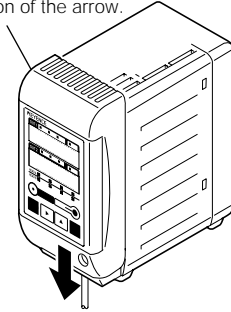

**CAUTION**

Be sure to check the orientation of the claws on the connector side before installation. Otherwise, the claws break and cause malfunction.

**5** Fix the display panel fixing case by tightening the display panel fixing screw.

**6** Route the display panel cable along the guide, and connect it to the display panel connector on the terminal panel of the controller.

## Connection

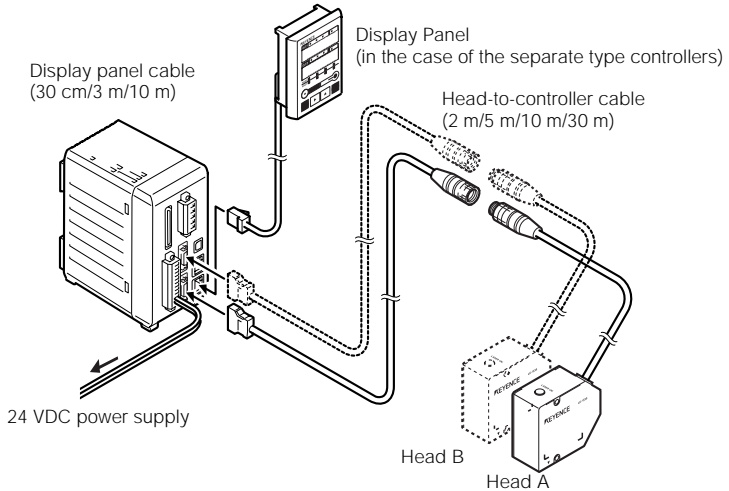

### ■ Connecting the head

Connect the connector of the head-to-controller cable to the head connector A or B on the controller's terminal panel. Check that a click sound is heard indicating that they are securely fixed. When removing it, pull it out while pressing the buttons on both sides of the connector. Up to two heads can be connected at the same time.

#### ⚠ CAUTION

- Be sure to turn off the power of the controller before connecting/disconnecting cables. Failure to do so may cause malfunction.
- Ensure that the orientation of the connector is correct. Otherwise the pin could break and may lead to system breakdown.

### ■ Connecting the display panel

In the case of the separate type controller, the display panel cable is used for connecting the controller to the display panel.

#### ■ Reference

The LK-G series can be operated without the display panel. In addition, the operation from a PC is possible by using the "LK-Navigator" software.

### ■ Connecting the power

Connect the 24V DC power to the terminals 1 and 2 of the 12-pin terminal block.

#### ■ Reference

KEYENCE CA-U2 or MS2 Series is recommended for the 24V DC power supply.

### ■ Connecting the terminal block

The steps to connect the wires to the terminal block are as follows:

#### 1 Remove the terminal block from the controller.

Loosen the two screws with a screwdriver and pull it out.

#### 2 Loosen the screws on the terminal with a screwdriver, and insert the lead wires into the terminal block.

The fabricating length of the pig-tail end of the lead wire should be about 6.5 mm.

#### 3 Tighten the lead wires with the screwdriver.

After tightening them, pull the lead wires lightly to confirm that they are securely fixed.

#### 4 Install the terminal block to the controller.

# Outline of Measurement and Settings

## Switching Modes

The LK-G has the following modes :

- \* Program switch mode : Switches between stored programs
- \* Tolerance setting mode : Sets "Hi" and "Lo" limits
- \* Setting mode : Used for setup of various functions and settings
- \* Measurement mode : Performs measurement

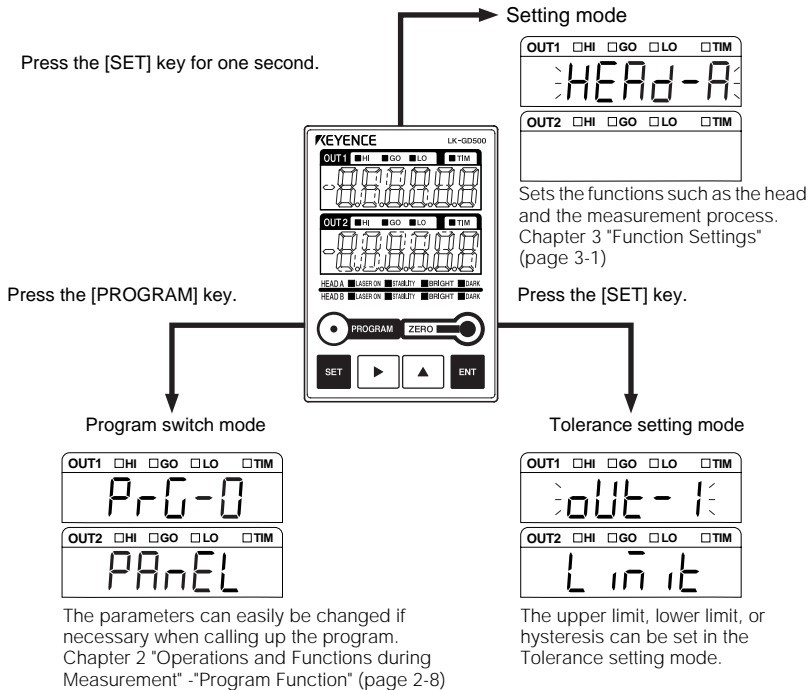

## Setting Mode

In the Setting mode, every time the  key is pressed, the setting content advances in this order : Head Setting → OUT Settings → Common Settings → Environment Settings.

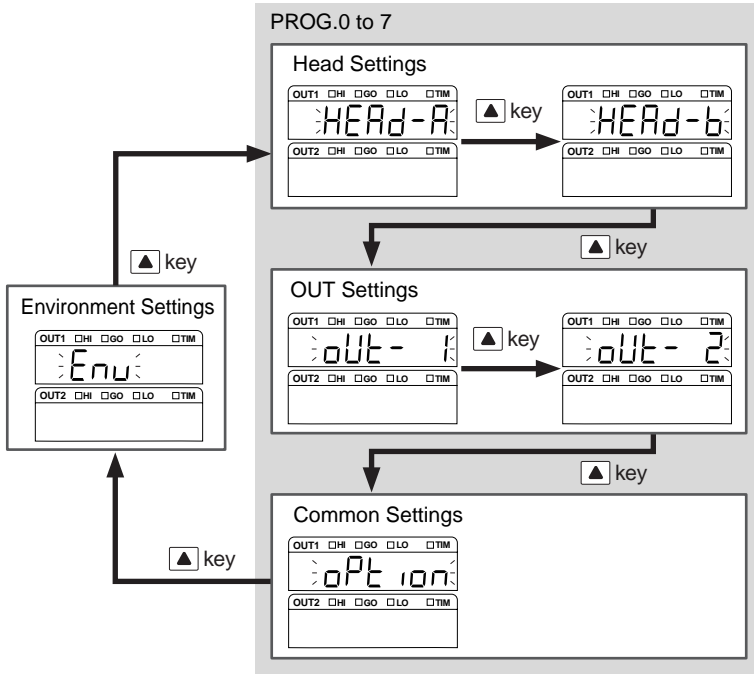

### PROG.0 to 7

Eight programs can be switched among Program Nos. 0 to 7 in the LK-G Series. You can register a set of parameters as a program according to the measurement process or the measuring target. The set parameters can easily be changed, if necessary, when calling up the desired program.

**Head setting :** The functions regarding sensing for stable detection can be set.

Setting contents : ABLE, Measurement mode, ALARM warning, ABLE calibration

 Refer to "Setting the Head" (page 3-3).

**OUT settings:** The functions regarding data processing can be set.

Setting contents : Calculation method, Scaling, Filter, Measurement mode, Trigger, Offset, Minimum display unit, Analog scaling, Analog through

 Refer to "Setting the Conditions of Measurement Value Output" (page 3-13).

**Common settings :** The common functions regarding the head setting and the OUT setting can be set.

Setting contents : Sampling rate, Mutual interference prevention, Timing synchronization, Comparator output format, Strobe time, Data storage

 Refer to "Setting the Common Settings" (page 3-37).



**Environment settings :** The operating environment of the LK-G series can be set.

Setting contents : RS-232C, Setting selection, Program, Panel lock, Eco mode

 Refer to "Setting the Operations of the Equipment (Environment Settings)" (page 3-46).

# Returning the LK-Series to the Factory Default Settings

You can initialize the controller and return the settings to the default settings when shipped from the factory.

- 1 While pressing the  key, turn on the power.**  
The measurement value indication shows " r.n.i.E".
- 2 When you press the  key again, the settings are initialized and the measurement state is established.**  
The settings return to the default setting when shipped from the factory.  
 Refer to "Chapter 3 Function Settings" (page 3-1).

MEMO

1



---

# Operations and Functions during Measurement

# 2

This chapter describes the operations that can be performed during displacement measurement and their functions.

Switching the Measurement Value Displays.....	2-2
Setting the Tolerance Comparator Values .....	2-3
Setting the Display Value Instantaneously to Zero (Auto-Zero) .....	2-6
Program Function .....	2-8
Switching Program Nos. ....	2-9
Performing Statistical Computation with the Measurement Value.....	2-10

# Switching the Measurement Value Displays

This section describes how to switch the measurement value display contents.

2

During measurement, the following three types of display can be switched. Press the  key to switch displays.

- OUT1 signal display
- OUT2 signal display
- OUT1/OUT2 dual display

Displays OUT1 and OUT2 at the same time (default)

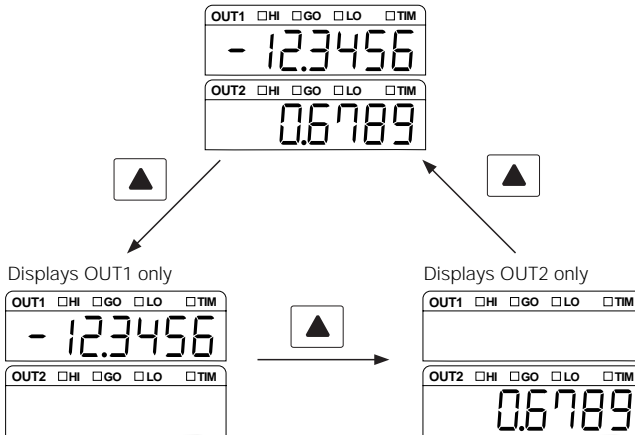

## Reference

The display type is retained for every program No.

# Setting the Tolerance Comparator Value

This section describes how to read the tolerance comparator display, and its setting procedure.

## The Function of the Tolerance Settings

HIGH and LOW comparator tolerance values can be set. The measured value can be displayed and output in 3 steps: when exceeding the HI comparator value (HI), when the value drops below the LOW comparator value (LOW), and when the value is between the HI and LOW comparator values (GO).

Comparator status	Range	Display
HIGH	HI comparator value < Measurement value	HI LED lights, and the measurement value is displayed in red.
GO	LO comparator value $\leq$ Measurement value $\leq$ HI comparator value	GO LED lights, and the measurement value is displayed in green.
LOW	Measurement value < LO comparator value	LO LED lights, and the measurement value is displayed in red.
Comparator standby state		No LED lights, and the measurement value is displayed as -----.

When the comparator output format is normal, the comparator output is as follows.

Refer to "Setting the Output Form of the Tolerance Comparator" (page 3-42) for the comparator output form.

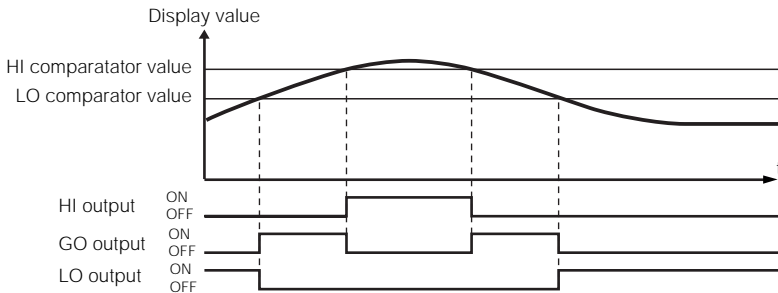

### Reference

The comparator result of tolerance is outputted from the 12-pin I/O terminal block and the expansion connector on the controller's terminal panel.

Refer to "Functions of the Input/Output Terminals" (page 4-2) for the external terminals.

**Note**

Measurement stops while the setting is in progress.

**Setting Procedures for tolerance comparator values.**

**1 Press the **SET** key.**

Enters the tolerance setting mode.

For changing the OUT No. to be set, press the **▲** key.

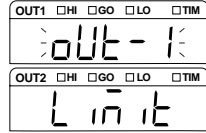

**2 Press the **ENT** key, and set the value with the **▶** and **▲** keys.**

As an example, the tolerance on the HI side of OUT1 is set to 4.0000.

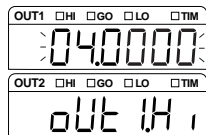

**3 Press the **ENT** key, and set the value with the **▶** and **▲** keys.**

As an example, the tolerance on the LO side of OUT1 is set to -4.0000.

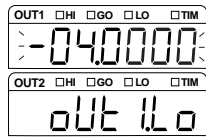

**4 Confirm the data by pressing the **ENT** key, and press the **SET** key to return to the measurement state.**

**Setting procedure of numerical values**

A numerical value can be set by the following key operations.

You can set the digit of a flashing number. When all digits are flashing, you can set symbols.

- When the **▶** key is pressed, the digit that flashes after all the digits flash shifts to the right. When pressed for one second or more it shifts in higher speed.



- When the **▲** key is pressed, the value increments. When pressed for one second or more, the value advances in higher speed.

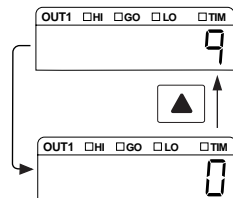

**Reference**

When the **ZERO** key is pressed for three seconds, the setting returns to the default value.

## Hysteresis

If the measurement value is fluctuating around the tolerance comparator value, the comparator output may repeatedly turn on and off. By setting a hysteresis, a gap may be generated between the detected value and the return value of the tolerance comparator, thus avoiding this phenomenon. When the comparator output format is normal, the comparator output is as follows. Hysteresis is not set by default when shipped from the factory.

Refer to "Setting the Output Form of the Tolerance Comparator" (page 3-42) for the comparator output form.

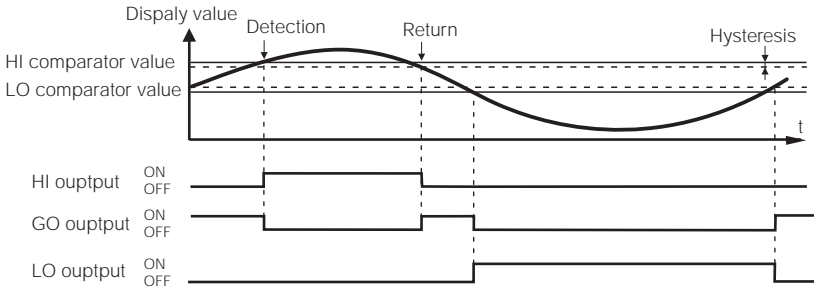

### Note

Measurement stops while the setting is in progress.

### Setting procedures of hysteresis

#### 1 Press the **SET** key.

Enters the tolerance setting mode.

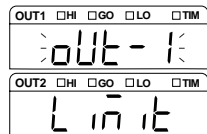

#### 2 Pressing the **▲** key shows the Hysteresis setting screen.

"HYS- 1" sets OUT1, and "HYS-2" sets OUT2.

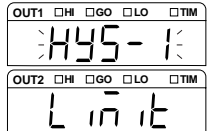

#### 3 Press the **ENT** key, and set the value with the **▶** and **▲** keys.

In this example, the hysteresis of OUT1 is set to "0.1000".



#### 4 Confirm the data by pressing the **ENT** key, and press the **SET** key to return to the measurement state.

## Setting the Display Value Instantaneously to Zero (Auto-Zero)

This section describes the auto-zero function, which is used for referencing zero-point position.

Operation of the  key or others resets the present displayed value to "0.0000". By considering this zero position as a reference, the increase and decrease are displayed in  $\pm$  (positive/negative). This function can be used for reference zero-point positioning when a workpiece is changed.

The example below uses the auto-zero function by using the 150- $\mu\text{m}$  target as a reference.

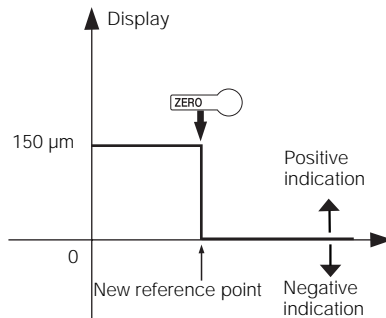

### ► Note

Auto-zero cannot be set at comparator standby state (displayed as "-----") and over-range state. However, cancellation of auto-zero is possible.

### Reference

- The auto-zero value is stored according to program No. and OUT.
- The auto-zero value is retained even if the power is turned off.
- When the measurement mode is other than normal, the comparator standby state ("-----") is established after auto-zero is set.
- Adjusting a master workpiece by using the offset function (auto offset function)  
When you set auto-zero while measuring a master workpiece, with the size of the master workpiece set as the offset value, the numerical value to display can be set to the size of the master workpiece (the offset value).

 Refer to "Measuring with Offset" (page 3-32).

## ■ Operations from the display panel

### 1 Measure the target to be used as a reference.

Assume that "1.2345" is displayed.

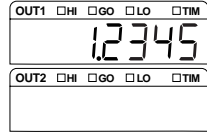

### 2 Press the key.

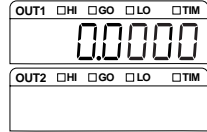

The measurement value display becomes zero.



#### Reference

- If you enable the auto-zero function for either OUT1 or OUT2 independently, the measurement value display mode must be set to the single display.
- If you enable the auto-zero function for both OUT1 or OUT2 at the same time, the measurement value display mode must be set to the dual display.

 Refer to "Switching the Measurement Value Displays" (page 2-2) for switching the measurement value display.

- The measurement value at the moment when the  key is released is set as "0.0000".
- Pressing the  key for three seconds cancels auto-zero.

## ■ Input from the ZERO terminal

Auto-zero starts functioning if you turn on ZERO1 (No.10) and COM on the 12-pin terminal block in the case of OUT1, and ZERO2 (No.8) on the expansion connector in the case of OUT2. Ensure that the turn-on time does not exceed two seconds.

- NPN type : OFF when opened/ON when short-circuited with COM (No.12)
- PNP type : OFF when opened/ON when the voltage is applied

#### Reference

The measurement value at the turning-on moment is set as "0.0000".

If the ZERO1 terminal or the ZERO2 terminal is turned on for two seconds or more, auto-zero is canceled.

## ■ RS-232C interface

You can send the command from the external devices by using the RS-232C interface to set or cancel the auto-zero function.

 Refer to "Chapter 5 RS-232C" (page 5-1).

# Program Function

Eight Programs can be switched among Program Nos. 0 to 7 in the LK-G Series. Register the setting contents that correspond to a measuring target as programs in advance. By calling up a program as desired, you can easily change the program.

2

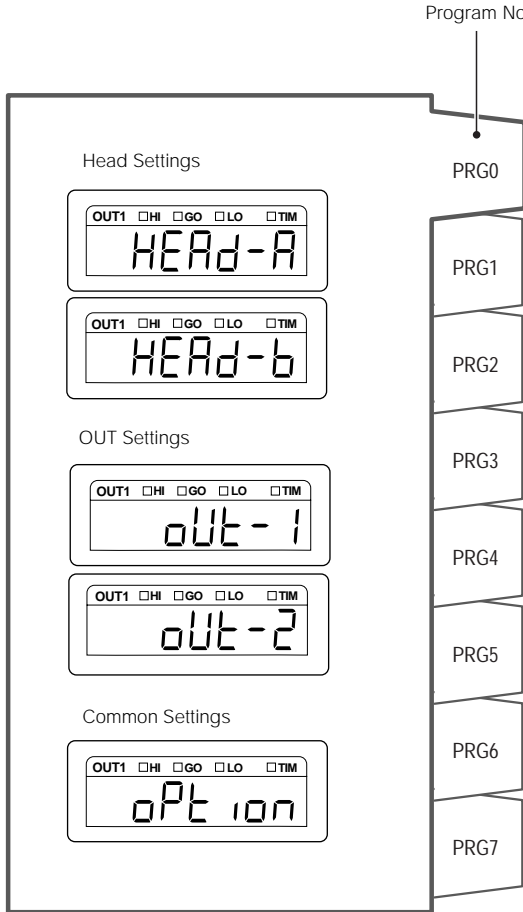

**▶ Note**

[Environment Settings] is not saved in the program.



# Switching Program Nos.

This section describes the Program No. switch function, which can easily change the operation settings.

## ■ Display panel

**1** Press the  **PROGRAM** key.  
The program selection screen appears.

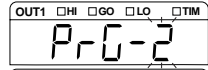

**2** Select a program No. by using the  key.



**3** Press the  **ENT** key to register it, and return to the measurement state.

## ■ External input terminal

Program No. can be changed by using the P1, P2, and P3 of the expansion connector.

 Refer to "Expansion Connector" (page 4-5).

## ■ RS-232C interface

You can send the command from the external devices by using the RS-232C interface to switch program Nos.

 Refer to "Chapter 5 RS-232C" (page 5-RS-232C).

### ▶ Note

The method of switching the program Nos. varies depending on the setting of "Setting the Program Switching Method" (page3-50) in the Environment settings.

Function No.	Selection item	Operation method
"b-0"	"PANEL"	Panel operation/RS-232C interface
"b-1"	"EXT"	External terminal input

# Performing Statistical Computation with the Measurement Value

2

Statistical computation with the measurement value can be performed. The data to be used for the statistical computation is the one held in each measurement mode. OUT1 and OUT2 can perform statistical computation independently.

 Refer to "Using the Hold Function (Measurement Mode)" (page 3-25).

Up to 90000 statistical data can be acquired. If the number exceeds 90000, the statistical computation stops.

The statistical computation is performed and the statistical data is updated continuously.

The statistical data is cleared under the following six conditions:

- When the  key is pressed for three seconds
- When moving to the Measurement mode from the Setting mode, Tolerance Settings mode, Program Change mode, or Communication mode
- When the statistics clearing command is received via the RS-232C interface
- When the clearing operation is performed on "LK-Navigator" software
- When a program No. is switched
- When the power is turned off

The upper OUT1 display shows the name of the statistical data, and the lower OUT2 display shows the statistical data.

The statistical data consists of the following 11 items.

OUT1 display	Name of statistical data	Description
<input type="checkbox"/> -SH i	Tolerance upper limit	Displays the upper limit of the tolerance setting.
<input type="checkbox"/> -SL o	Tolerance lower limit	Displays the lower limit of the tolerance setting.
<input type="checkbox"/> -RuG	Average value	Displays the average value of the measurement data.
<input type="checkbox"/> -toP	Maximum value	Displays the maximum value of the measurement data.
<input type="checkbox"/> -bot	Minimum value	Displays the minimum value of the measurement data.
<input type="checkbox"/> -d iF	Maximum value – minimum value	Displays the difference between the maximum value and the minimum value.
<input type="checkbox"/> -Std	Standard deviation	Displays the standard deviation of the measurement data.
<input type="checkbox"/> -no	Number of all data	Displays the number of all the measurement data.
<input type="checkbox"/> -h i	Number of tolerance HI data	Displays the number of data that exceed the upper limit of the tolerance.
<input type="checkbox"/> -Go	Number of tolerance GO data	Displays the number of data found within the tolerance range.
<input type="checkbox"/> -Lo	Number of tolerance LO data	Displays the number of data that are below the lower limit of the tolerance.

\*  is displayed as "i" at OUT1, and as "2" at OUT2.

■ **Setting procedures of statistical data**

**1 Press the  key to change the screen to show the single display.**

Set the OUT No. of which statistical data is to be displayed.

**2 Press the  key.**

The screen changes to the statistical data display.

The upper limit of the tolerance setting is displayed.

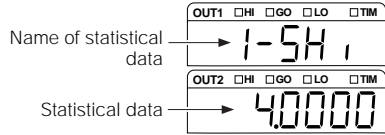

**3 Press the  key and check the statistical data in order.**

For details of the displaying order, refer to  page 2-10.

**4 Press the  key to return to the measurement value display.**

▶ **Note**

When displaying both OUT1 and OUT2 during measurement, the statistics cannot be displayed.

■ **Reference**

- The measurement and statistical computation are performed even when the statistical data are displayed.
- In the statistics display screen, if no key operation is performed for 60 seconds, the screen returns to the measurement state.

MEMO

2

---

# Function Settings

# 3

This chapter describes the functions of the LK-G Series and the setting procedures.

Measurement, Data Flow and Functions .....	3-2
Setting the Head.....	3-3
Setting the Conditions of the Measurement Value Output .....	3-13
Setting the Common Functions .....	3-37
Setting the Operations of the Equipment (Environment Settings) .....	3-46

# Measurement, Data Flow and Functions

The LK-G Series can connect two heads. Each head can perform measurement individually, and the measurement values between the heads can be calculated.

3

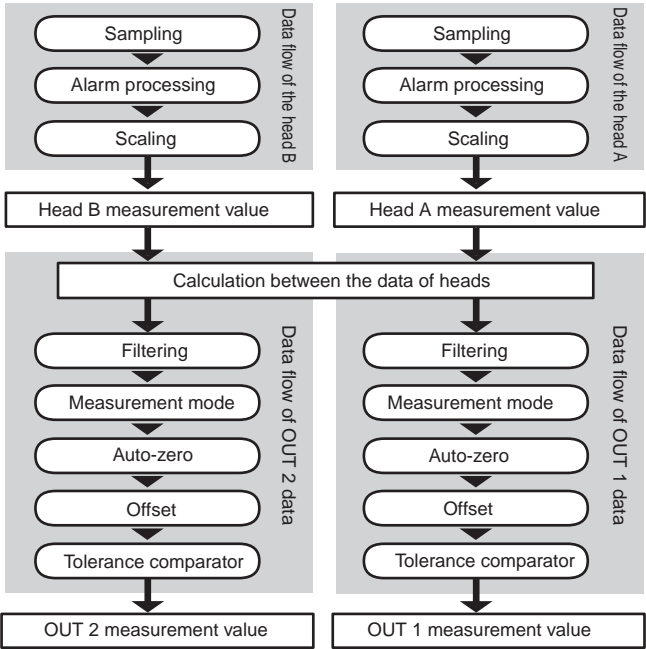

The functions of the LK-G Series can be categorized into the following four groups.

Head Settings	The functions related to sensing for stable detection are set.
OUT Settings	The functions related to data processing are set.
Common Settings	The common functions related to the Head settings and the OUT settings are set.
Environment Settings	The operating environment of the LK-G Series is set.

### ■ Function and function display

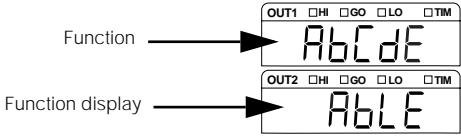

# Setting the Head

This section describes the settings related to the sensing for stable detection.

## List of Functions and Function Nos.

Function	Function display	Function No.					Reference page
		0	1	2	3	4	
<b>R</b>	Light intensity adjustment	AUTO	MANUAL				3-5
	<b>AbLE</b>	<b>RUto</b>	<b>nRnUPL</b>				
<b>b</b>	Measurement mode	Normal	Translucent object	Transparent object	Transparent object 2	Multi-reflective object	3-7
	<b>nERS</b>	<b>nor nPL</b>	<b>HRLF-t</b>	<b>trRn-1</b>	<b>trRn-2</b>	<b>nS</b>	
<b>Ɔ</b>	Alarm process	Count setting ( <b>Ɔount</b> , 0 to 999, <b>8</b> )					3-8
	<b>RLRr n</b>	Level ( <b>LEuEL</b> , 0 to 9, <b>4</b> )					
<b>d</b>	ABLE calibration	START/STOP					3-10
	<b>AbLE-t</b>	<b>StArt/Stop</b>					
<b>E</b>	Mounting mode	Diffuse reflection	Mirror reflection				3-12
	<b>nount</b>	<b>dIFF-S</b>	<b>nIRR-S</b>				

\* The shaded cells are set by default.

## List of Default Values and Setting Ranges

Function	Item	Settable range	Default value	Remarks
<b>R</b>	ABLE	-	AUTO	
	Upper limit of control	1 to 99	99	
	Lower limit of control	1 to 99	1	
<b>b</b>	Measurement mode	Normal / Translucent object / Transparent object / Transparent object 2 / Multi-reflective object	Normal	
<b>Ɔ</b>	Number of times of processing	0 to 999	8	
	Level	0 to 9	4	
<b>d</b>	ABLE calibration	START/STOP	-	
<b>E</b>	Mounting mode	Diffuse reflection / Mirror reflection	Diffuse reflection	

List of the Head Setting Screens

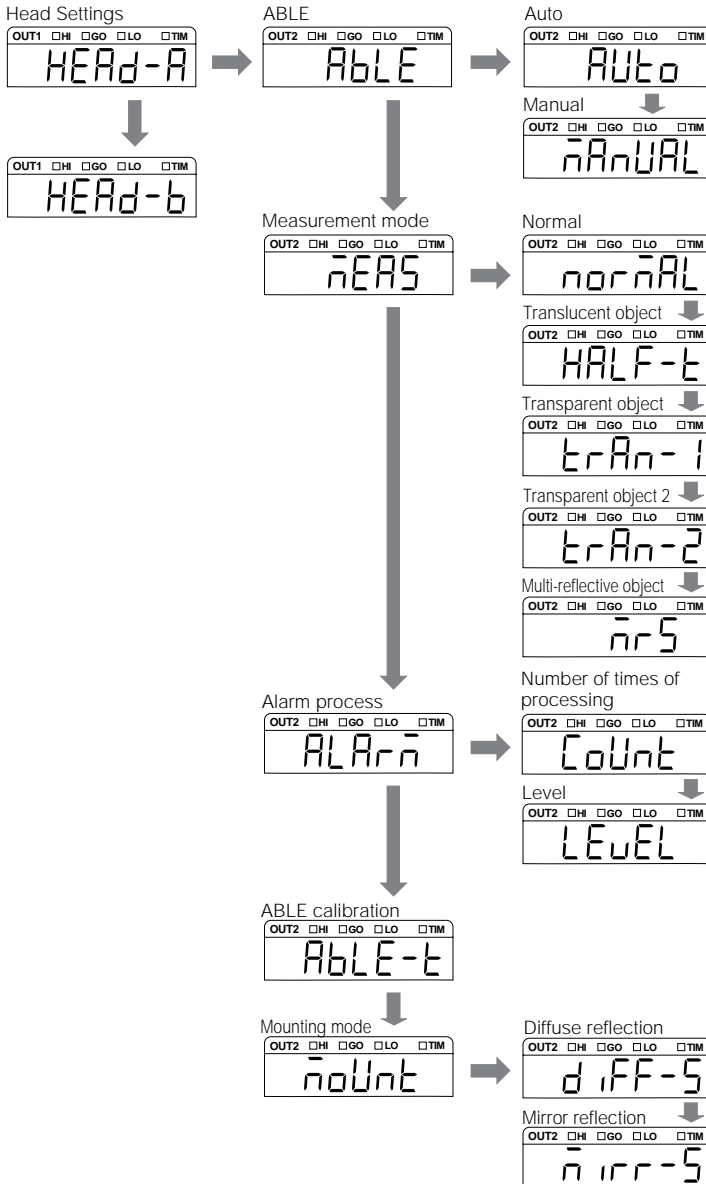

3



## Setting ABLE

The LK-G Series measures the displacement of the target by measuring the laser beam reflected from the surface of the target. The ABLE function automatically adjusts the light intensity and the sensitivity to their optimum levels according to the conditions (color, luster, and material) of the target surface.

The following two types of setting are available for ABLE.

Function No.	Light intensity adjustment	Function
<b>R-0 AUTO</b>	Auto	Automatically adjusts the light intensity to the optimum level. Select this in normal cases.
<b>R-1 RnURL</b>	Manual	The light intensity and sensitivity can be adjusted by limiting the adjustment range to the desired range between 1 and 99. Select this when the reflective rate of the target changes rapidly and drastically, or when only detection of the target is required.

3

### ■ Setting procedure of ABLE (AUTO)

- 1** Hold down the **SET** key, and select "HEAD-R" with the **▲** key.  
"Head A" is set in this example.
- 2** Press the **ENT** key, and select the function "R" by the **▶** key.  
Set ABLE.
- 3** Press the **ENT** key, and select "R-0" with the **▲** key.  
Select "AUTO".
- 4** Press the **ENT** key to register the setting. Press the **SET** key to return to the measurement state.

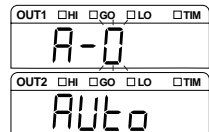
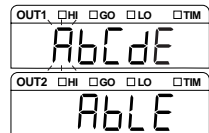
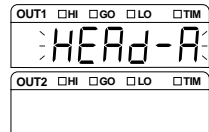

■ Setting procedure of ABLE (MANUAL)

1 Hold down the **SET** key, and select "HEAD-R" with the **▲** key.

"Head A" is set in this example.

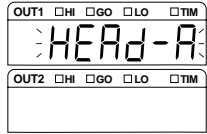

2 Press the **ENT** key, and select the function "A" with the **▶** key.

Set ABLE.



3 Press the **ENT** key, and select "R- I" with the **▲** key.

Select "manual".



4 Press the **ENT** key, and set the value for the higher limit with the **▶** and **▲** keys.

"60" is set in this example.

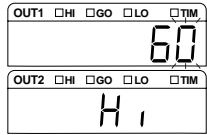

5 Press the **ENT** key, and set the value for the lower limit with the **▶** and **▲** keys.

"20" is set in this example.

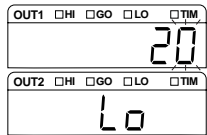

6 Press the **ENT** key to register the setting. Press the **SET** key to return to the measurement state.

3

## Setting the Measurement Mode According to the Measuring Target

Specifying the features of the measuring target stabilizes the detection.  
Select the corresponding type from the following list.

Function No.	Target workpiece	Description
b-0 nor nRL	Normal	Select this setting in normal cases.
b-1 HRL F-t	Translucent object	Used for a target that absorbs light such as a translucent resin.
b-2 trAn-1	Transparent object	Used for displacement measurement or thickness measurement of a transparent object. Used when the reflective ratio of multiple surfaces on a transparent object is the same.
b-3 trAn-2	Transparent object 2	Used when the reflective ratio of the multiple surfaces (up to four phases) on the transparent object is different.
b-4 n-5	Multi-reflective object	Used to measure the bending of an IC or connector terminal.

### ► Note

- To obtain optimal control over detection of the four surfaces, the sampling rate of [Transparent object 2] is quadrupled at maximum. Be sure to attach the ND filter (□ page 1-9).
- When selecting the transparent object, transparent object 2, or multi-reflective object, set the sampling rate (□ page 3-39) to other than 20 μs (other than 20 μs and 50 μs when Transparent object 2 is selected in the LK-G155/G150/G157/G152).

### ■ Setting procedure of the measurement mode

- 1** Hold down the **SET** key, and select "HEAD-A" with the **▲** key.  
"Head A" is set in this example.

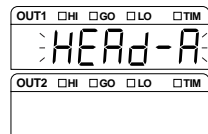

- 2** Press the **ENT** key, and select the function "b" with the **▶** key.  
Set the measurement mode.

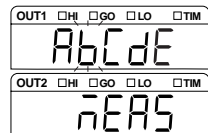

- 3** Press the **ENT** key, and select "b-2" with the **▲** key.  
"Transparent object" is selected in this example.

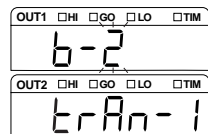

- 4** Press the **ENT** key to register the setting. Press the **SET** key to return to the measurement state.

**Specifying the Process When Measurement is Not Possible (Alarm Process)**

The measurement is disabled when measurement overrange occurs or the light intensity is not adequate. The alarm process specifies how to process the data in these situations.

The alarm process has the following two types.

Setting	Function
Count <b>Count</b>	Specifies the number of samples the previous measured value is held for after measurement is disabled. <ul style="list-style-type: none"> <li>• Setting range: 0 to 999</li> <li>• If the measurement remains disabled even after the number of times of processing exceeds the specified value, the measurement value is displayed as -FFFFFF.</li> <li>• Holding is released when the system recovers to the measurement state within the specified number of times of processing.</li> <li>• When the number of times of processing is set as "999", the normal value continues to be retained until the measurement is enabled.</li> </ul>
Level <b>LEVEL</b>	Sets the threshold level of the received light status to be judged as not measurable. Setting range: 0 to 9 "0" is the least sensitive to the alarm, and "9" is the most sensitive to it.

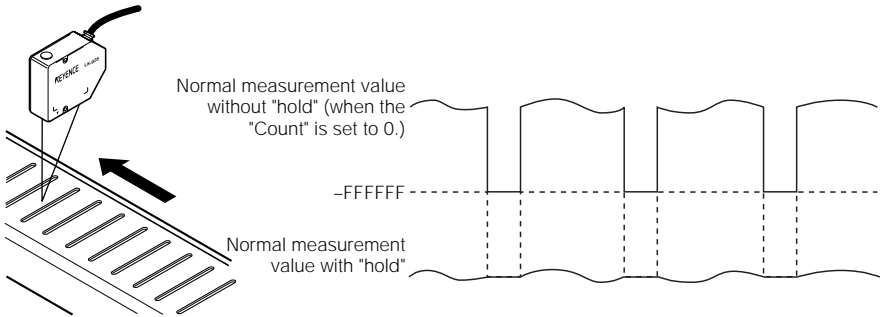

The measurement disabled state on a hole and the like can be cancelled.

### ■ Setting procedure of the alarm process

- 1** Hold down the **SET** key, and select "HEAD-R" with the **▲** key.

"Head A" is set in this example.



- 2** Press the **ENT** key, and select the function "L" with the **▶** key.

Set the alarm process.

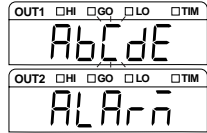

- 3** Press the **ENT** key, and set the number of times with the **▶** and **▲** keys.

"500" times is set in this example.

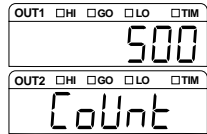

- 4** Press the **ENT** key, and specify the level with the **▲** key.

"8" is set in this example.

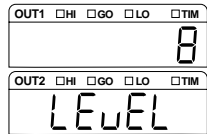

- 5** Press the **ENT** key to register the measurement result.  
Press the **SET** key to return to the measurement state.

#### Automatically Teching the Adjustment Range of ABLE According to the Target

The ABLE calibration function optimizes the adjustment range of ABLE by actually measuring the target. Use this function when the reflective ratio of the target changes drastically in a short cycle.

##### ■ Procedure of the ABLE calibration

3

- 1 Measure an actual target as shown in the following figure.**
- 2 Start the ABLE calibration.**  
The data acquisition starts.
- 3 Move the target slowly.**
- 4 Complete the ABLE calibration.**  
The data acquisition is completed, and the optimum ABLE range is set.

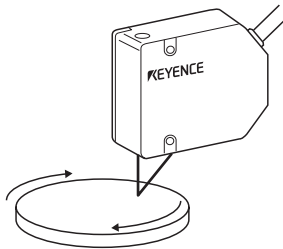

##### Reference

When ABLE calibration is performed, ABLE of function "A" is set to MANUAL, and the upper and lower limits of control are set to the adjusted values.

By slowly moving the target, the adjustment range of ABLE can be optimized. By optimizing the adjustment range, the responsiveness when the reflectivity drastically changes in rapid cycle can be enhanced.

### ■ Setting procedure of the ABLE calibration

- 1** Hold down the **SET** key, and select "HEAd-R" with the **▲** key.

"Head A" is set in this example.



- 2** Press the **ENT** key, and select the function "d" with the **▶** key.

Set the ABLE calibration process.



- 3** Press the **ENT** key to display "StArT". Press the **ENT** key again to start measurement.

"StoP" indicates that the target is being measured.



- 4** Press the **ENT** key to register the measurement result.  
Press the **SET** key to return to the measurement state.

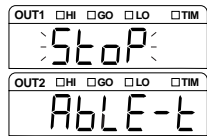

## Setting the Mounting Mode

The LK-G Series measures the displacement of the target by measuring the reflected laser beam. When much of the surface of the target is specular, such as a mirror or glass, the mirror-reflection component of the reflective light increases. In such a case, set the mirror reflection setup to receive the mirror reflection light.

In such a case, mount the head for mirror reflection.

The following two types of mounting mode are available.

Function No.	Mounting mode	Function
E-0 d,FF-5	Diffuse reflection	Sets head for diffuse reflection. Select this in normal cases.
E-1 n,rr-5	Mirror reflection	Sets head for mirror reflection mode. Select this when the measurement target is a mirror, glass or other specular surfaces.

### ■ Setting procedure of the mounting mode

- 1** Hold down the **SET** key, and select "HEAD-A" with the **▲** key.

"Head A" is set in this example.

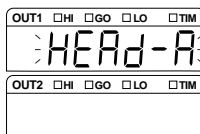

- 2** Press the **ENT** key, and select the function "E" with the **▶** key.

Set the mounting mode.



- 3** Press the **ENT** key, and select "E-0" with the **▲** key.

Select the diffuse reflection mode.

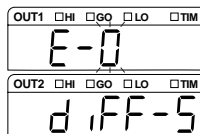

- 4** Press the **ENT** key to register the setting. Press the **SET** key to return to the measurement state.

### ▶ Note

When the LK-G15/LK-G10 is connected, the setting of the mounting mode is invalid.



# Setting the Conditions of the Measurement Value Output

The functions related to data processing are set.

## List of Functions and Function Nos.

Function	Function	Function No.						Reference page
		0	1	2	3	4	5	
<b>R</b>	Calculation method	Head A	Head B	Head A + B	Head A _ B	Transparent object A displacement / thickness	Transparent B displacement / thickness	3-18
	<b>CRALC</b>	<b>A</b>	<b>b</b>	<b>ADD-A+B</b>	<b>SUB-A-B</b>	<b>TRAN-A</b>	<b>TRAN-b</b>	
<b>b</b>	Scaling	Head A	Head B					3-20
	<b>SCAL</b>	<b>A-INP</b>	<b>b-INP</b>					
<b>ε</b>	Filter	Average	Low-pass filter	High-pass filter				3-22
	<b>FILTER</b>	<b>AUG</b>	<b>LPF</b>	<b>HPF</b>				
<b>d</b>	Measurement mode	Normal	Peak hold	Bottom hold	P-to-P hold	Sample-and-hold	Average hold	3-25
	<b>Hold</b>	<b>NORMAL</b>	<b>P-H</b>	<b>b-H</b>	<b>PP-H</b>	<b>SP-H</b>	<b>AUG-H</b>	
<b>E</b>	Trigger	Trigger 1	Trigger 2					3-31
	<b>TRIG</b>	<b>TR1</b>	<b>TR2</b>					
<b>F</b>	Offset							3-32
	<b>OFFSET</b>							
<b>G</b>	Minimum display unit	Displayed in mm	Displayed in mm	Displayed in mm	Displayed in mm	Displayed in μm	Displayed in μm	3-33
	<b>DECPLE</b>	<b>0.01</b>	<b>0.001</b>	<b>0.0001</b>	<b>0.00001</b>	<b>0.1</b>	<b>0.01</b>	
<b>H</b>	Analog output scaling							3-34
	<b>R-SCAL</b>							
<b>i</b>	Analog-through	OFF	ON					3-36
	<b>R-THRU</b>	<b>OFF</b>	<b>ON</b>					

\* The shaded cells are set by default.

### 3 Function Settings

Functions "A" and "C" specify the following sub-functions.

Sub-function	Function	Function No.					
		0	1	2	3	4	5
<b>A-4</b>	Head-A transparent object	Surface 1	Surface 2	Surface 3	Surface 4	Surface 1 – Surface 2	Surface 1 – Surface 3
	<b>trAn-A</b>	<b>1</b>	<b>2</b>	<b>3</b>	<b>4</b>	<b>1-2</b>	<b>1-3</b>
<b>A-5</b>	Head-B transparent object	Surface 1	Surface 2	Surface 3	Surface 4	Surface 1 – Surface 2	Surface 1 – Surface 3
	<b>trAn-b</b>	<b>1</b>	<b>2</b>	<b>3</b>	<b>4</b>	<b>1-2</b>	<b>1-3</b>
<b>C-0</b>	Moving-average	1 time	4 times	16 times	64 times	256 times	1024 times
	<b>MAVG</b>	<b>1</b>	<b>4</b>	<b>16</b>	<b>64</b>	<b>256</b>	<b>1024</b>
<b>C-1</b>	Low-pass filter	1000 Hz	300 Hz	100 Hz	30 Hz	10 Hz	3 Hz
	<b>LPF</b>	<b>1000</b>	<b>300</b>	<b>100</b>	<b>30</b>	<b>10</b>	<b>3</b>
<b>C-2</b>	High-pass filter	1000 Hz	300 Hz	100 Hz	30 Hz	10 Hz	3 Hz
	<b>HPF</b>	<b>1000</b>	<b>300</b>	<b>100</b>	<b>30</b>	<b>10</b>	<b>3</b>

Sub-function	Function	Function No.				Reference page
		6	7	8	9	
<b>A-4</b>	Head-A transparent object	Surface 1 – Surface 4	Surface 2 – Surface 3	Surface 2 – Surface 4	Surface 3 – Surface 4	3-18
	<b>trAn-A</b>	<b>1-4</b>	<b>2-3</b>	<b>2-4</b>	<b>3-4</b>	
<b>A-5</b>	Head-B transparent object	Surface 1 – Surface 4	Surface 2 – Surface 3	Surface 2 – Surface 4	Surface 3 – Surface 4	3-18
	<b>trAn-b</b>	<b>1-4</b>	<b>2-3</b>	<b>2-4</b>	<b>3-4</b>	
<b>C-0</b>	Moving-average	4096 times	16384 times	65536 times	262144 times	3-22
	<b>MAVG</b>	<b>4096</b>	<b>16384</b>	<b>65536</b>	<b>262144</b>	
<b>C-1</b>	Low-pass filter	1 Hz	0.3 Hz	0.1 Hz		3-23
	<b>LPF</b>	<b>1</b>	<b>0.3</b>	<b>0.1</b>		
<b>C-2</b>	High-pass filter	1 Hz	0.3 Hz	0.1 Hz		3-23
	<b>HPF</b>	<b>1</b>	<b>0.3</b>	<b>0.1</b>		

\* The shaded cells are set by default.

### List of Default Values and Setting Ranges

Function	Item	Settable range	Default value	Remarks
<b>R</b>	Calculation method	Head A/Head B/Head A + Head B/Head A-Head B/ Head A transparent object displacement-thickness/Head B transparent object displacement-thickness	Head A	
	Calculation between waveforms	1/2/3/4/1-2/1-3/1-4/2-3/2-4/3-4	1	When the transparent object displacement/ thickness is selected for the calculation method
<b>b</b>	Input value of the first point	-99.9999 to +99.9999	0.0000	
	Display value of the first point	-99.9999 to +99.9999	0.0000	
	Input value of the second point	-99.9999 to +99.9999	+1.0000	
	Display value of the second point	-99.9999 to +99.9999	+1.0000	
<b>Ɛ</b>	Number of times of moving average	1/4/16/64/256/1024/4096/16384/65536/262144	256	
	Cutoff frequency	1000/300/100/30/10/3/1/0.3/0.1	100 Hz	The LPF and HPF have the same settable range.
<b>d</b>	Measurement mode	Normal/peak hold/bottom hold/ peak-to-peak hold/average hold/ sample-and-hold	Normal	
<b>E</b>	Trigger	Trigger 1/Trigger 2	Trigger 1	
<b>F</b>	Offset	-99.9999 to +99.9999	0.0000	
<b>G</b>	Minimum display unit	0.01/0.001/0.0001/0.00001/0.1/0.01	0.0001	
<b>H</b>	Display value of the first point	-99.9999 to +99.9999	+1.0000	
	Output value of the first point	-10.5 V to +10.5 V	+10.000	
	Display value of the second point	-99.9999 to +99.9999	-1.0000	
	Output value of the second point	-10.5 V to +10.5 V	-10.000	
<b>i</b>	Analog-through	ON/OFF	OFF	
Tolerance	Tolerance upper limit	-99.9999 to +99.9999	+5.0000	
	Tolerance lower limit	-99.9999 to +99.9999	-5.0000	
	Hysteresis width	0 to +99.9999	+0.0000	

**List of the OUT Setting Screens**

3

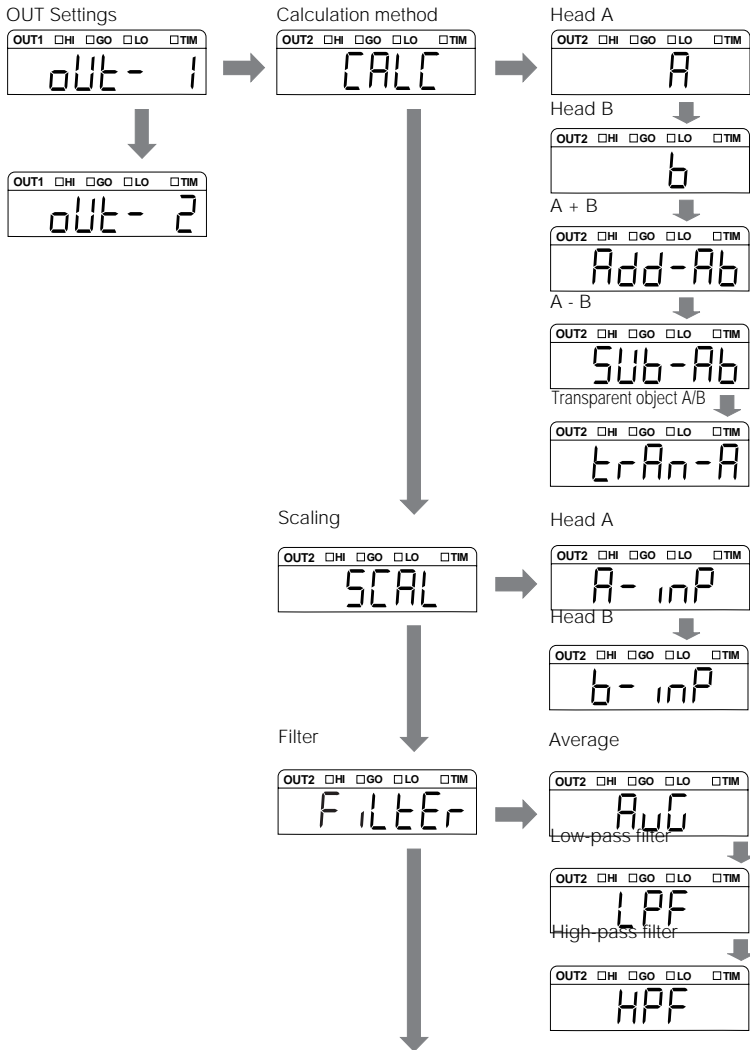

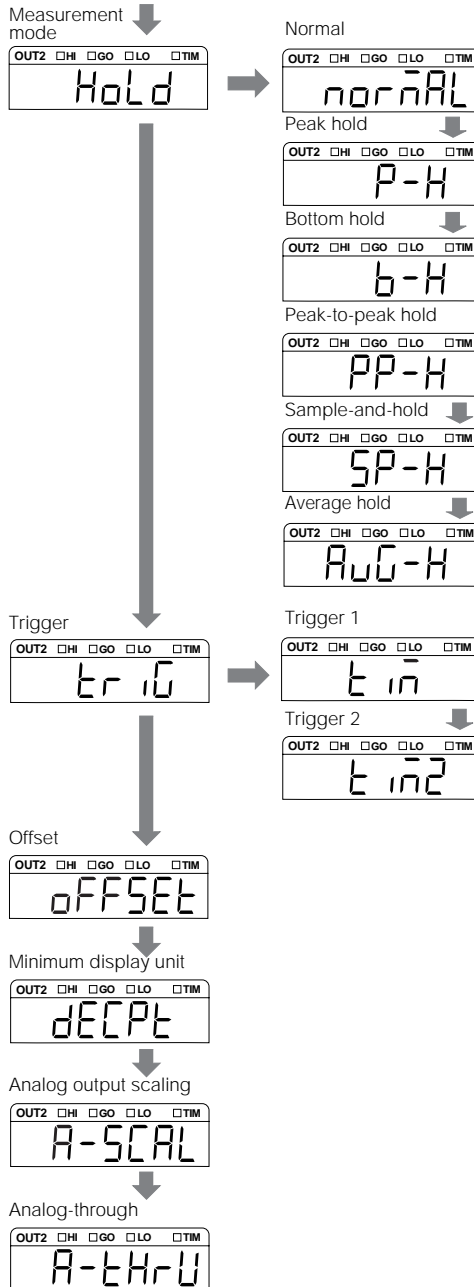

## Calculating Between the Heads

The surface displacement, thickness, and height-difference measurements can be performed by calculating the data acquired from the setting of head A or head B according to the measurement target.

### ■ Function Nos. and measurement examples

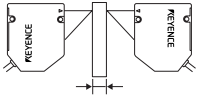
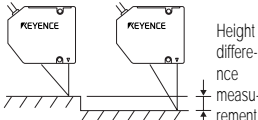
Function No.	Calculation	Function
<b>R-0 R</b>	Head A	Surface displacement measurement using the head A or B
<b>R-1 R</b>	Head B	
<b>R-2 Add-Rb</b>	Head A + B	Thickness measurement using the head A and B  Thickness measurement
<b>R-3 Sub-Rb</b>	Head A - B	Height-difference measurement using the head A and B  Height difference measurement
<b>R-4 trRn-R</b>	Head-A transparent object	Performs the displacement measurement and thickness measurement of the transparent object. The measurement surface is selected by the sub-function.
<b>R-5 trRn-b</b>	Head-B transparent object	

\* Used in combination with the auto offset function.  
 When transparent object is selected for the measurement mode of head setting, head A and head B perform surface measurement if **Add-Rb** or **Sub-Rb** is selected.

### ■ Sub-functions and measurement surfaces

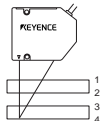
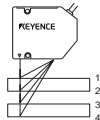
Sub-function	Measurement surface	Function
<b>R-□ 0 1</b>	1	Displacement measurement of one surface 
<b>R-□ 1 2</b>	2	
<b>R-□ 2 3</b>	3	
<b>R-□ 3 4</b>	4	
<b>R-□ 4 1-2</b>	1-2	Measurement and calculation of two phases By selecting "4", the thickness of the first sheet of glass can be measured. By selecting "7", the gap between the first and the second sheets of glass can be measured. 
<b>R-□ 5 1-3</b>	1-3	
<b>R-□ 6 1-4</b>	1-4	
<b>R-□ 7 2-3</b>	2-3	
<b>R-□ 8 2-4</b>	2-4	
<b>R-□ 9 3-4</b>	3-4	

\*When **trRn-R** is selected: □ = 4, when **trRn-b** is selected: □ = 5

### ■ Setting procedure of the calculation between heads

- 1** Hold down the **SET** key, and select "out- 1" with the **▲** key.

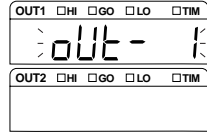

- 2** Press the **ENT** key, and select the function "A" by the **▶** key.  
Select the calculation.



- 3** Press the **ENT** key, and select "A-2" with the **▲** key.  
The addition of head A and B is selected in the function.

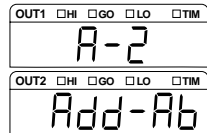

- 4** Press the **ENT** key to register the setting. Press the **SET** key to return to the measurement state.



### ■ Setting procedure for measuring thickness of transparent target 1, 2 follow steps 1 & 2 from the previous section.

- 3** Press the **ENT** key, and select "A-4" with the **▲** key.  
Head A's transparent object is set in this example.

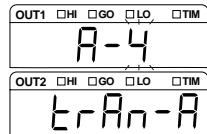

- 4** Press the **ENT** key, and select "A-44" with the **▲** key.  
Measurement between surface ends 1 - 2 is selected in this example.

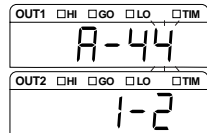

- 5** Press the **ENT** key to register the setting. Press the **SET** key to return to the measurement state.

#### ▶ Note

When [Transparent object 2] (📖 page 3-7) is specified, select the measurement surface on which the object to be measured actually exists.

## Setting the Scaling for Measurement (Calibration)

The displayed value for the measurement value can be calibrated as desired.  
Set the values to display for the desired two points to calibrate.

### ■ Setting procedure of scaling

This section describes the setting procedure of the following calibration as an example.

Setting content		Setting value	Display
Point 1	Original input value 1	-1.0200	<i>R1,inp1</i>
	Calibrated displayed value 1	-1.0000	<i>R1d,SP</i>
Point 2	Original input value 2	0.9900	<i>R2,inp2</i>
	Calibrated displayed value 2	1.0000	<i>R2d,SP</i>

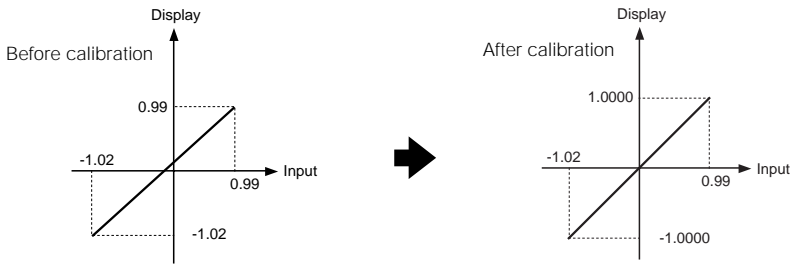

**1** Hold down the **SET** key, and select "out - I" with the **▲** key.

OUT 1 is set in this example.

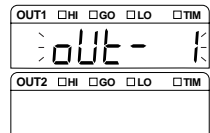

**2** Press the **ENT** key, and select the function "b" with the **▶** key.

Set the scaling.



**3** Press the **ENT** key, and select "b-0".





- 4** Press the **ENT** key to set the input value 1 of the head A, point 1 by using the **▶** and **▲** keys.

The current measurement value is loaded if the **ZERO** key is pressed.



- 5** Press the **ENT** key to set the input value 1 of the head A, point 1 by using the **▶** and **▲** keys.



- 6** Press the **ENT** key to set the input value 2 of the head A, point 2 by using the **▶** and **▲** keys.

The current measurement value is loaded if the **ZERO** key is pressed.



- 7** Press the **ENT** key to set the input value 2 of the head A, point 2 by using the **▶** and **▲** keys.



- 8** Press the **ENT** key to register the measurement result.  
Press the **SET** key to return to the measurement state.

#### ▶ Note

When the following conditions are not satisfied, "Err-7" is displayed and the setting cannot be performed. Press the **ENT** key to cancel the error, and set the scaling again.

(1) Input value 1 - Input value 2  $\neq$  0

(2)  $\left| \frac{\text{Displayed value 2} - \text{Displayed value 1}}{\text{Input value 2} - \text{Input value 1}} \right| < 10$

#### Reference

If the **ZERO** key is pressed while inputting the value, the current measurement value is inputted. If it is pressed for three seconds, the default value is inputted.

## Stabilizing the Measurement by Filtering

The following three types of function can be set for the filter function.

Function No.	Filter name	Function
[-0] AVG	Average	Performs moving-average of the measurement value. Sets the number of times of averaging.
[-1] LPF	Low-pass filter	Cuts extreme changes and only captures moderate fluctuations. Set the cutoff frequency.
[-2] HPF	High-pass filter	Cuts moderate fluctuations and only captures extreme changes. Set the cutoff frequency.

3

### ■ Averaging function

Performs moving-average of the measurement value within the range of 1 to 262144 times.

The following is the example of the process when an averaging value of four is set.

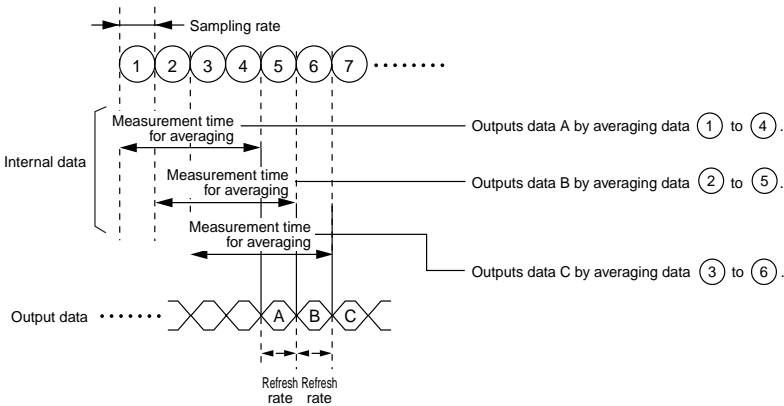

#### Reference

The sampling rate, measurement time for averaging, and refresh rate vary depending on the settings.

Refer to "Response Delay Time" (6-16 page).

### ■ Functions of the low-pass filter and high-pass filter

Set the cutoff frequency for each of the filters.

The process when the filter is set is as follows.

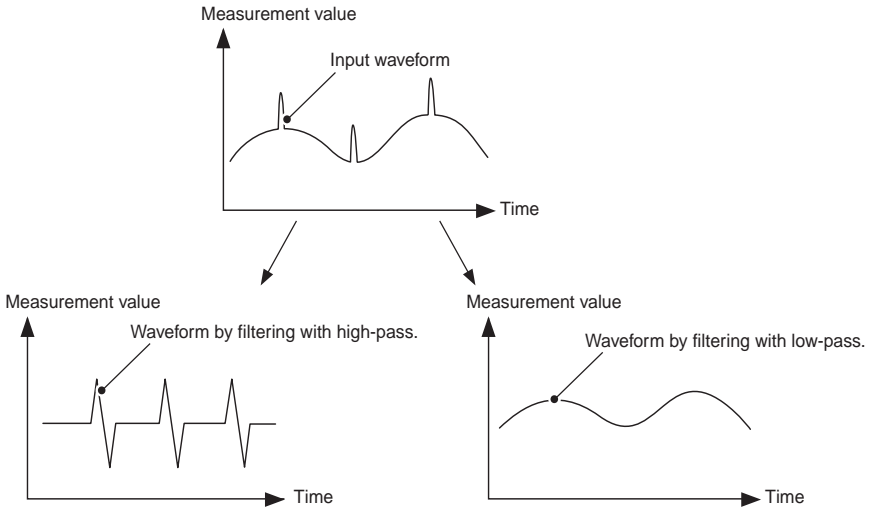

### ■ Setting procedure of averaging

The setting procedure is described below for the case where the averaging is set to OUT1 as an example.

- 1** Hold down the **SET** key, and select "OUT - I" with the **▲** key.

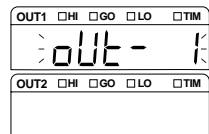

- 2** Press the **ENT** key, and select the function "F" with the **▶** key.

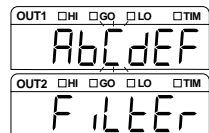

Set the filter.

- 3** Press the **ENT** key, and select "C-0" with the **▲** key.  
Set "Moving average".

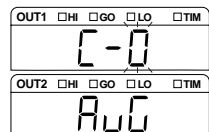

- 4** Press the **ENT** key, and specify the number of times of moving average with the **▲** key.

"1024" times is selected in this example.



- 5** Press the **ENT** key to register the setting. Press the **SET** key to return to the measurement state.

3

■ Setting procedure of the low-pass filter/high-pass filter

The setting procedure is described below for the case where the low-pass filter is set to OUT1 as an example.

- 1** Hold down the **SET** key, and select "OUT - !" with the **▲** key.

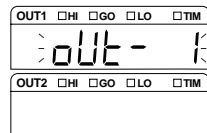

- 2** Press the **ENT** key, and select the function "C" with the **▶** key.



- 3** Press the **ENT** key, and select "C - !" with the **▲** key.

"LPF (low-pass filter)" is selected in this example.

Select "C - 2" to select "HPF (high-pass filter)".

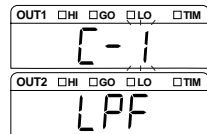

- 4** Press the **ENT** key, and select "C - L3" with the **▲** key.

Cutoff frequency is set as "30" Hz in this example.

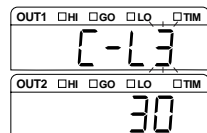

- 5** Press the **ENT** key to register the setting. Press the **SET** key to return to the measurement state.

▶ Note

When the sampling rate (  page 3-39) is 1000  $\mu$ s and 500  $\mu$ s, and the cutoff frequency is set to 1000 Hz and 300 Hz, the operating frequency becomes 100 Hz. When the sampling rate is 200  $\mu$ s, and the cutoff frequency is set as 1000Hz, the operating frequency becomes 300 Hz.

## Using the Hold Function (Measurement Mode)

This section describes the six types of measurement modes.

The function of each measurement mode is as follows.

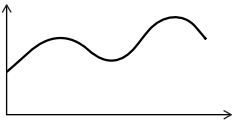
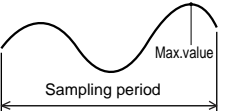
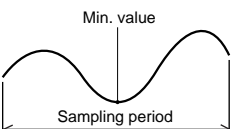
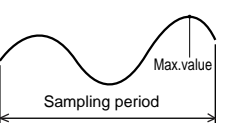
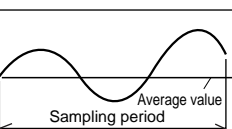
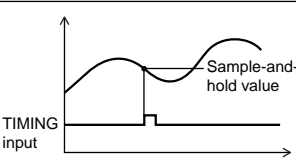
Function No.	Mode name	Description		Reference page
<b>d-0</b> <i>nor nRL</i>	Normal	The measured result can be displayed or outputted as required.		page 3-27
<b>d-1</b> <i>P-H</i>	Peak hold	The maximum value during the specified period can be measured.		page 3-28
<b>d-2</b> <i>b-H</i>	Bottom hold	The minimum value during the specified period can be measured.		page 3-28
<b>d-3</b> <i>PP-H</i>	Peak-to-peak hold	The differential value of the maximum and minimum values during the specified period can be measured.		page 3-28
<b>d-4</b> <i>SP-H</i>	Average hold	The average value during the specified period can be measured.		page 3-28
<b>d-5</b> <i>RUH-H</i>	Sample-and-hold	The value at the specified moment can be measured.		page 3-29

For the sampling period, Trigger 1 and Trigger 2 are available depending on the trigger setting.

 Refer to "Setting the Trigger Condition" (page 3-31) for setting the trigger.

■ Setting procedure of the measurement mode

The setting procedure is described below for the case where peak hold is set to OUT1 as an example.

- 1** Hold down the **SET** key, and select "OUT - 1" with the **▲** key.

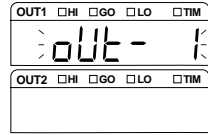

- 3** **2** Press the **ENT** key, and select the function "d" with the **▶** key.  
Select Hold.



- 3** Press the **ENT** key, and select "d- 1" with the **▲** key.  
"Peak hold" is selected in this example.

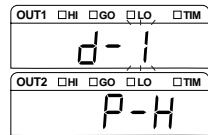

- 4** Press the **ENT** key to register the setting. Press the **SET** key to return to the measurement state.

## Timing Chart

### ■ Normal

Measurement is performed consecutively, and the measurement value is displayed and outputted as required.

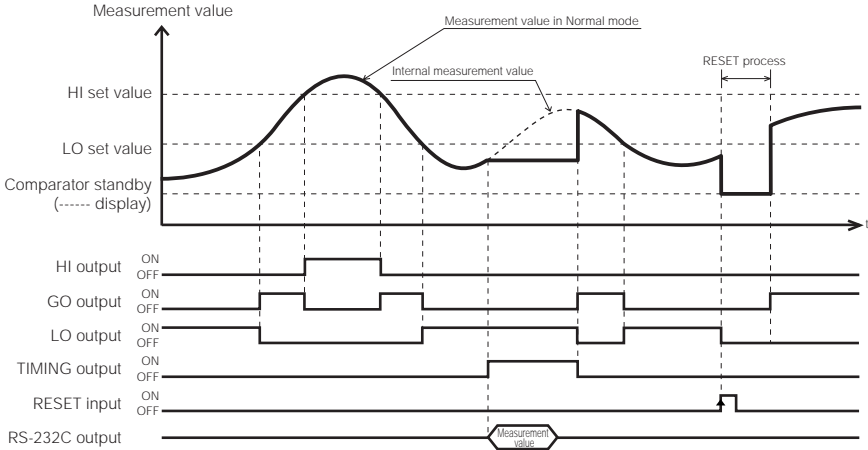

- The ON state of each output indicates the state where the NPN or PNP open-collector output is turned on.
- The ON state of each input indicates the state where it is short-circuited between the terminal and the COM terminal for NPN type, and the voltage is applied between the terminal and the COM terminal.
- The RS-232C output is synchronized with the timing input when "Auto transmission" in the Environment setting is set other than OFF. (page 3-49)

Refer to "Functions of the Input and Output Signals" (page 4-7) for details of binary output.

### Reference

If the RESET input is set to ON when the TIMING input is ON, the comparator standby state (the display shows "-----") is displayed until the TIMING input becomes OFF.

- The TIMING input and RESET input can be controlled using the RS-232C (page 5-8).
- There is no difference between the functions of Trigger 1 and Trigger 2.

#### ■ Peak hold/bottom hold/peak-to-peak hold/average hold

The values within the period of time (sampling period) determined by the external TIMING input are measured, and the display and output are retained. The sampling period differs between Trigger 1 and 2.

Peak hold	Measures the maximum value within the specified period of time (sampling period).
Bottom hold	Measures the minimum value within the specified period of time (sampling period).
Peak-to-peak hold	Measures the differential value of the maximum and minimum values within the specified period of time (sampling period).
Average hold	Measures the average value within the specified period of time (sampling period).

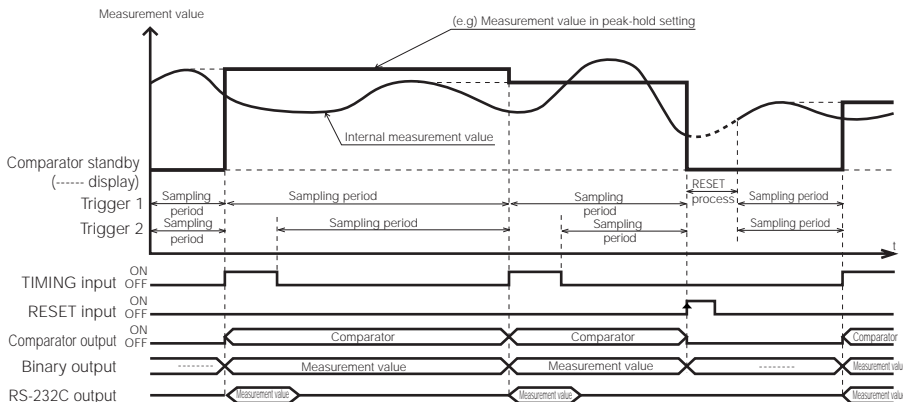

- For Trigger 1, the sampling period indicates the period of time from the moment the TIMING input turns on until the moment it turns on again. When the TIMING input turns ON, the measurement value in the sampling period immediately before is outputted. The RESET process is not performed when the TIMING input is turned on.
- For Trigger2, the sampling period indicates the period of time in which the TIMING input is OFF. When the TIMING input turns ON, the measurement value in the sampling period immediately before is output. The RESET process of the internal measurement value is performed when the timing input is turned off.
- In the following cases, the comparator standby status (the display shows "-----") is displayed until the first measurement value is fixed. When the power is turned on/when a setting is changed/when a program No. is changed/when RESET is inputted/when Auto-zero is inputted
- The comparator output is outputted according to the measurement value.
- The ON state of each output indicates the state where the NPN or PNP open-collector output is turned on.
- The ON state of each input indicates the state where it is short-circuited between the terminal and the COM terminal for NPN type, and the voltage is applied between the terminal and the COM terminal.
- The RS-232C output is synchronized with the timing input when "Auto transmission" in the Environment setting is set other than OFF. (page 3-49)
- Refer to "Functions of the Input and Output Signals" (page 4-7) for details of binary output.
- If the TIMING input becomes ON during the RESET processing, the comparator standby status (the display shows "-----") is displayed.
- When the internal measurement value becomes the alarm state, the measurement result varies depending on the settings of the alarm process.  
With hold: The measurement result is outputted by using the value immediately before the retained value.  
Without hold: The measurement value is outputted while ignoring the alarm state period at the time of peak hold. When the whole sampling period is in the alarm state, the alarm (-FFFFFF) becomes the measurement result. At the time of other than peak hold, the alarm (-FFFFFF) becomes the measurement result.

#### Reference

The TIMING input and RESET input can be controlled using the RS-232C (page 5-8).

#### ▶ Note

- Set the average filter (the number of times for averaging) to 1 if the measurement mode is set to average hold.
- When the mode is set without the alarm hold, and a large value is set for the average number of times, the measurement result may not trigger an alarm. Check the alarm output to ensure that the alarm state is properly recognized.



## ■ Sample-and-hold (Trigger 1)

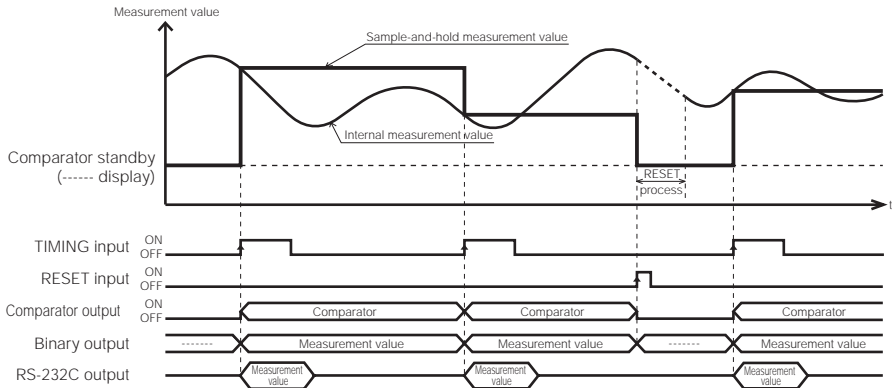

- The internal measurement value when the TIMING input becomes ON is retained and outputted.
- In the following cases, the comparator standby status ("-----" is indicated) is displayed until the first measured value is fixed.  
When the power is turned on/when the setting is changed/when the program No. is changed/  
when RESET is inputted/when auto-zero is inputted
- The comparator output is outputted according to the measurement value.
- The ON state of each input indicates the state where the NPN or PNP open-collector output is turned on.
- The ON state of each input indicates the state where it is short-circuited between the terminal and the COM terminal for NPN type, and the voltage is applied between the terminal and the COM terminal.
- The RS-232C output is synchronized with the timing input when "Auto transmission" in the Environment setting is set other than OFF. (page 3-49)

### Reference

The TIMING input and RESET input can be controlled using the RS-232C (page 5-8).

### ► Note

When the mode is set without the alarm hold, and a large value is set for the average number of times, the measurement result may not trigger an alarm. Check the alarm output to ensure that the alarm state is properly recognized.

#### ■ Sample-and-Hold (Trigger 2)

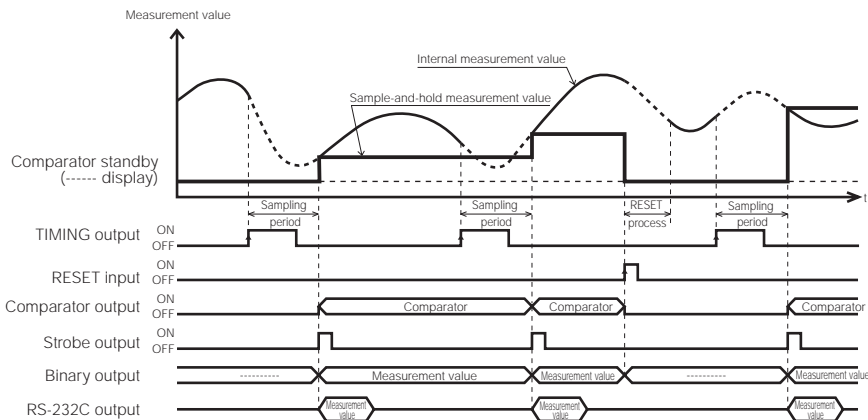

- When the TIMING input is turned on, the internal measurement value is retained and outputted. That value is fixed by sampling the data acquired in the same number of times of averaging since the TIMING input is on.
- In the following cases, the comparator standby status (the display shows "-----") is displayed until the first measured value is fixed.  
When the power is turned on/when the setting is changed/when the program No. is changed/  
when RESET is inputted/when auto-zero is inputted
- The comparator output is outputted according to the measurement value.
- The ON state of each output indicates the state where the NPN or PNP open-collector output is turned on.
- The ON state of each input indicates the state where it is short-circuited between the terminal and the COM terminal for NPN type, and the voltage is applied between the terminal and the COM terminal.
- The RS-232C output is synchronized with the timing input when "Auto transmission" in the Environment settings is set to other than OFF.
- If the TIMING input is turned on during the RESET process, the system stops the RESET process and starts sampling.
- When the internal measurement value becomes the alarm state (measurement overrange or inadequate light intensity), the measurement result varies depending on the settings of the alarm process.  
With hold: The measurement result is outputted by using the value immediately before the retained value.  
Without hold: The alarm (-FFFFFF) becomes the measurement result.
- If you turn on the RESET input or the ZERO input during the sampling period, the sampling stops and the comparator standby state is established.

#### Reference

- The TIMING input and RESET input can be controlled via RS-232C (page 5-8).
- The Strobe output time can be changed. Refer to "Setting the Strobe Output Time" (3-43 page) for details.

#### ► Note

- When the mode is set without the alarm hold, and a large value is set for the average number of times, the measurement result may not trigger an alarm. Check the alarm output to ensure that the alarm state is properly recognized.
- Set the filter to [Average]. [Count] can be set as desired.

Refer to "Stabilizing the Measurement by Filtering" (3-22 page) for setting the filter.

## Setting the Trigger Condition

Trigger 1 and trigger 2 differ in terms of the sampling period during which the measurement value is retained in the measurement mode. Refer to "Using the Hold Function (Measurement Mode)" (page 3-25) for the details of the timing difference.

Function No.	Trigger	Function		
		Normal	Peak hold / bottom hold / peak-to-peak hold / average hold	Sample-and-hold
E-0 TIM1	Trigger 1	Holds the internal measurement value when the timing signal rises while the signal is ON.	The sampling period is from the rising edge of the timing signal until the next rising edge.	Holds the internal measurement value when the timing signal rises.
E-1 TIM2	Trigger 2		The sampling period is from the falling edge of the timing signal until the next rising edge.	When the timing signal rises, the data worth the preset average number of times is sampled from that time, and the settled internal measurement value is held.

- 1** Hold down the **SET** key, and select "OUT - I" with the **▲** key.

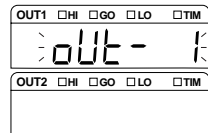

- 2** Press the **ENT** key, and select the function "E" with the **▶** key.  
Select Hold.

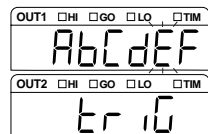

- 3** Press the **ENT** key, and select "E - I" with the **▲** key.  
"Trigger 2" is selected in this example.

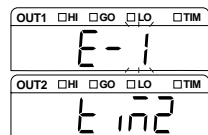

- 4** Press the **ENT** key to register the setting. Press the **SET** key to return to the measurement state.

## Measuring with Offset

You can add or subtract any value to or from the displayed value. When the offset value is set, it can be displayed when the auto-zero is performed.

Refer to "List of Default Values and Setting Ranges" (3-37 page) for the setting range and its restriction.

### Reference

Adjusting the master workpiece by using the auto-zero function (auto offset function)  
The size of the master workpiece can be set as the master value (reference value), if you set the size of the master workpiece as the offset value, and then use the auto-zero function while measuring the master workpiece.

### Setting procedure of the offset value

The setting procedure is described below for the case where offset is set for OUT1 as an example.

- 1** Hold down the **SET** key, and select "OUT - I" with the **▲** key.

OUT1 is chosen for this example.

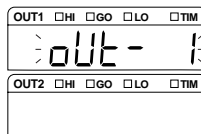

- 2** Press the **ENT** key, and select the function "F" with the **▶** key.

Set the offset.

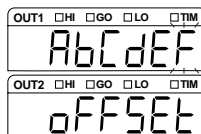

- 3** Press the **ENT** key, and set the offset value with the **▶** and **▲** keys.

"0.03" is set in this example.



- 4** Press the **ENT** key to register the setting. Press the **SET** key to return to the measurement state.

## Setting the Unit and the Minimum Display Unit

The display unit and the minimum display unit can be selected from the following six types of units.

Function No.	Minimum display unit	Unit	Displayable range
G-0 0.0 1	0.01	mm	- 9999.99 to + 9999.99
G-1 0.00 1	0.001	mm	- 999.999 to + 999.999
G-2 0.000 1	0.0001	mm	- 99.9999 to + 99.9999
G-3 0.0000 1	0.00001	mm	- 9.99999 to + 9.99999
G-4 0.1	0.1	μm	- 99999.9 to + 99999.9
G-5 0.0 1	0.01	μm	- 9999.99 to + 9999.99

### ■ Setting procedure of the number of digits to be displayed and the position of the decimal point

- 1** Hold down the **SET** key, and select "OUT - I" with the **▲** key.

OUT 1 is set in this example.

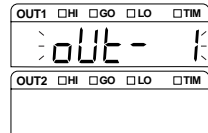

- 2** Press the **ENT** key, and select the function "G" with the **▶** key.

Set the display unit and the minimum display unit.



- 3** Press the **ENT** key, and select "G-3" with the **▲** key.

Set the unit to mm and the minimum display unit to 0.00001.



- 4** Press the **ENT** key to register the setting. Press the **SET** key to return to the measurement state.

#### ▶ Note

If the unit and the minimum display unit are changed, the setting content related to the numerical value display within the same OUT in the same program No. and the auto-zero setting value is initialized.

## Scaling the Analog Output

The analog voltage output can be scaled into the output voltage value within the range of  $\pm 10.5$  V.

When setting the scaling, specify the analog output values for the display value of the desired two points.

The scaling of the analog current output (4 to 20 mA) is set by calculating the electric current value to the voltage value by using the following formula.

$$\text{The voltage value (V)} = (\text{the electric current value (mA)} - 12 \text{ mA}) / 0.8$$

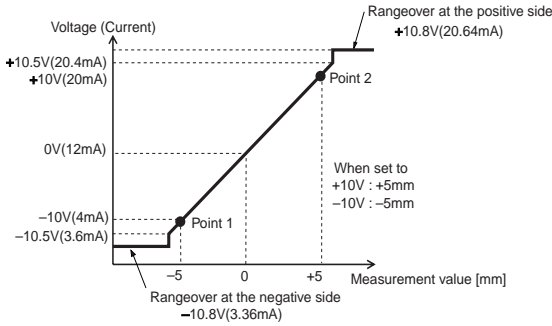

**Note**

When the following conditions are not satisfied, "Err-7" is displayed and the setting cannot be performed. Press the **ENT** key to cancel the error, and set the scaling again.

- (1) Input value 1 - Input value 2  $\neq$  0
- (2)  $\left| \frac{\text{Output voltage value 2} - \text{Output voltage value 1}}{\text{Displayed value 2} - \text{Displayed value 1}} \right| \leq 10$

The output voltage is calculated by 1 mV, and the displayed value by 0.01  $\mu$ m regardless of the specified unit and the minimum display unit.

**Setting procedure of the monitor output**

The following settings are performed.

Measurement content		Measurement value	Display
Point 1	Displayed value 1	-5.0000	1-d.5P
	Analog output voltage value 1	-10.000	1-0Vt
Point 2	Displayed value 2	5.0000	2-d.5P
	Analog output voltage value 2	10.000	2-0Vt

- 1** Hold down the **SET** key, and select "out - I" with the **▲** key.

OUT 1 is set in this example.

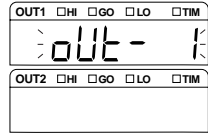

- 2** Press the **ENT** key, and select the function "H" with the **▶** key.

Set the scaling of the analog output.

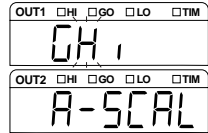

- 3** Press the **ENT** key, and set the display value of point 1 by using the **▶** and **▲** keys.

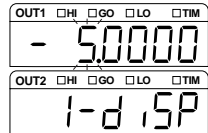

- 4** Press the **ENT** key, and set the output value of point 1 by using the **▶** and **▲** keys.

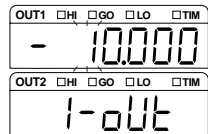

- 5** Press the **ENT** key, and set the display value of point 2 by using the **▶** and **▲** keys.

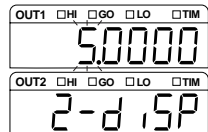

- 6** Press the **ENT** key, and set the output value of point 2 by using the **▶** and **▲** keys.

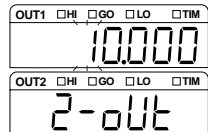

- 7** Press the **ENT** key to register the setting. Press the **SET** key to return to the measurement state.

## Outputting the Analog Output Without Holding

The internal measurement value before being retained is outputted when the analog-through is set to ON while the measurement value is retained in the measurement mode.

### Setting procedure of the analog-through

- 1** Hold down the **SET** key, and select "OUT - I" with the **▲** key.

OUT 1 is set in this example.

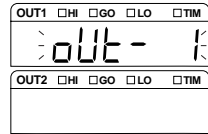

- 2** Press the **ENT** key, and select the function "I" with the **▶** key.

Set the analog-through.

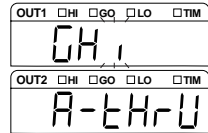

- 3** Press the **ENT** key, and select "I - I" with the **▲** key.

The analog output is output by through.

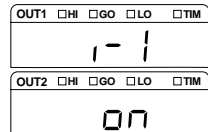

- 4** Press the **ENT** key to register the setting. Press the **SET** key to return to the measurement state.

3



# Setting the Common Function

This section describes the functions common to each program No.

## List of Functions and Function Nos.

Function	Function	Function No.						Reference page
	Function display	0	1	2	3	4	5	
<b>R</b>	Sampling rate	20 $\mu$ s	50 $\mu$ s	100 $\mu$ s	200 $\mu$ s	500 $\mu$ s	1000 $\mu$ s	3-39
	<b>RYCLE</b>	20	50	100	200	500	1000	
<b>b</b>	Mutual interference prevention	OFF	ON					3-40
	<b>RLtEr</b>	oFF	oN					
<b>l</b>	Timing synchronization	Asynchronous	Synchronous					3-41
	<b>SYNl</b>	n-SYNl	SYNl					
<b>d</b>	Comparator output format	Normal	HOLD	Off-delay				3-42
	<b>a-FoRn</b>	noRnRL	HoLd	dELAY				
<b>E</b>	Strobe time	2 ms	5 ms	10 ms	20 ms			3-43
	<b>S-t, nE</b>	2	5	10	20			
<b>F</b>	Data storage	OFF	OUT1	OUT2	OUT 1 + 2			3-44
	<b>d-Str</b>	oFF	oUt 1	oUt 2	oUt i2			

\* The shaded cells are set by default.

\* Function "F" sets the number of data and accumulation rate as a sub-function.

 Refer to "Accumulating the Measurement Value in the Memory (Data Storage Function)" (page 3-54).

## List of Default Values and Setting Ranges

Function	Item	Settable range	Default value	Remarks
<b>R</b>	Sampling rate	20/50/100/200/500/1000 $\mu$ s	200 $\mu$ s	
<b>b</b>	Mutual interference prevention	ON/OFF	OFF	
<b>l</b>	Timing synchronization	Synchronous/asynchronous	Asynchronous	
<b>d</b>	Comparator output format	Normal/hold/delay	Normal	
<b>E</b>	Strobe time	2/5/10/20 ms	2 ms	
<b>F</b>	Data selection	OFF/OUT1/OUT2/OUT1.2	OFF	
	Number of data	1 to 65536	65536	
	Accumulation rate	1/2/5/10/20/50/100/200/500/1000	x 20	

**List of the Common Function Setting Screens**

3

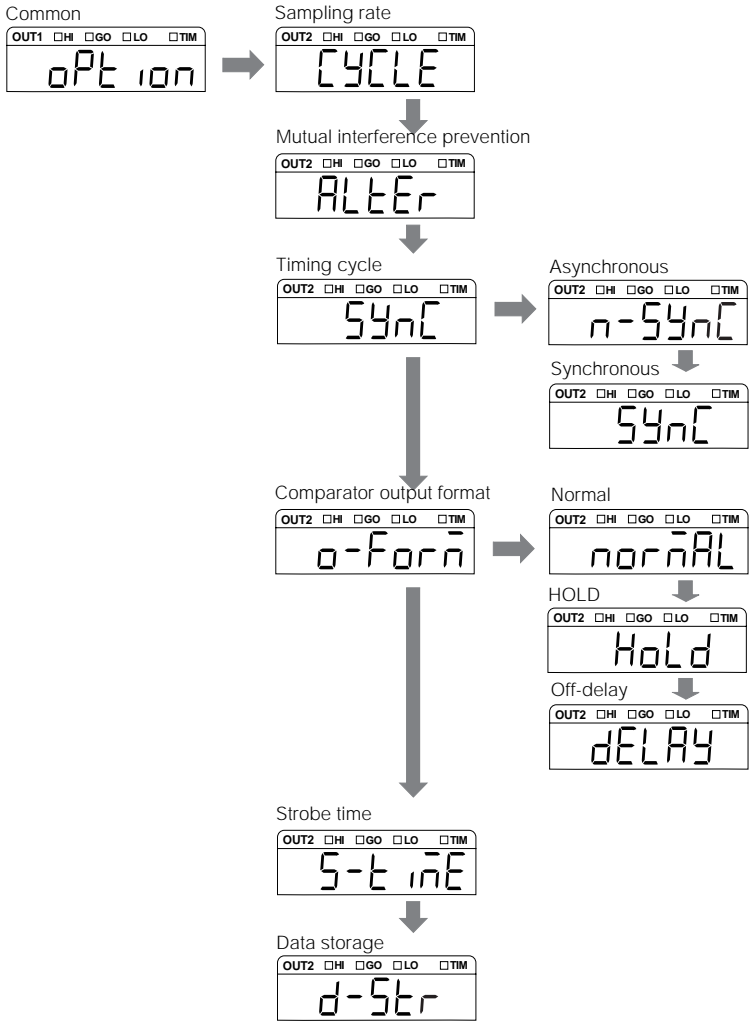

## Setting the Sampling Rate of Measurement Value

This section describes how to set the measurement sampling cycle. If you want the sampling to be performed more quickly, modify it to perform faster or when the received light is extremely dim, modify it to perform more slowly.

Function No.	Function (sampling rate)
R-0 20	20 $\mu$ s
R-1 50	50 $\mu$ s
R-2 100	100 $\mu$ s
R-3 200	200 $\mu$ s
R-4 500	500 $\mu$ s
R-5 1000	1000 $\mu$ s

### ■ Setting procedure of the sampling rate

- 1** Hold down the **SET** key, and select "oPl ion" with the **▲** key.  
Set the common settings.

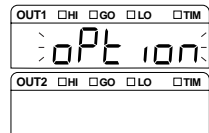

- 2** Press the **ENT** key, and select the function "R" by the **▶** key.  
Set the sampling cycle.



- 3** Press the **ENT** key, and select "R-4" with the **▲** key.  
The sampling rate is set as "500"  $\mu$ s in this example.

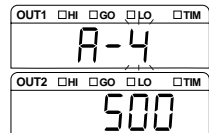

- 4** Press the **ENT** key to register the setting. Press the **SET** key to return to the measurement state.

### ▶ Note

- The sampling rate will be doubled when two heads are connected and the sampling rate is set as 20  $\mu$ s.
- Set the sampling rate to other than 20  $\mu$ s (other than 20  $\mu$ s and 50  $\mu$ s for Transparent object 2 in the LK-G155/G150/G157/G152) when one of the items from transparent object, transparent object 2, and multi-reflective object is selected in the measurement mode of the head ( page 3-7).
- The sampling rate will be up to four times faster when the transparent object 2 is selected.

## Setting the Mutual Interference Prevention Function

When two heads are connected and a little distance is left between them, a measurement error may occur by receiving the light emitted from the other head. The mutual interference prevention function is used in such a case.

When the mutual interference prevention function is set to ON, the two heads emit the laser beam alternately to evade the interference from the other.

When the measurement point is close

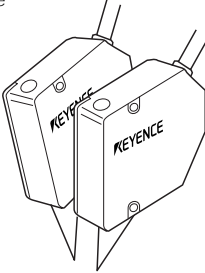

When measuring the thickness of the transparent object

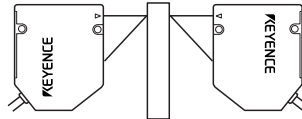

### Setting procedure of the mutual interference prevention function

- 1 Hold down the **SET** key, and select "oPl ion" with the **▲** key.  
Set the common settings.

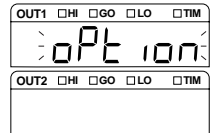

- 2 Press the **ENT** key, and select the function "b" with the **▶** key.  
Set the mutual interference prevention function.



- 3 Press the **ENT** key, and select "b-!" with the **▲** key.  
The mutual interference prevention function is set to "ON" in this example.

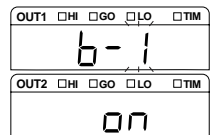

- 4 Press the **ENT** key to register the setting. Press the **SET** key to return to the measurement state.



#### ▶ Note

The sampling rate is doubled when the mutual interference prevention function is set to ON.

## Setting the External Timing Input

The control method for the timing inputs of OUT1 and OUT2 can be set. The following functions can be specified by the settings.

Function No.	Timing synchronization	Function
[-] 0 n-54n[-]	Asynchronous	Controls OUT1 and OUT2 asynchronously. Assigns independent input terminals for each of OUT1 and OUT2. <ul style="list-style-type: none"> <li>• OUT1: No. 8 of the 12-pin I/O terminal block</li> <li>• OUT2: No. 6 of the expansion connector</li> </ul>
[-] 1 54n[-]	Synchronous	Controls OUT1 and OUT2 synchronously. No. 8 of the 12-pin I/O terminal triggers OUT1 & OUT2, and No. 6 of the expansion connector becomes invalid.

3

### ■ Setting the timing synchronization

- 1** Hold down the **[SET]** key, and select "oPt, on" with the **[▲]** key.  
Set the common settings.

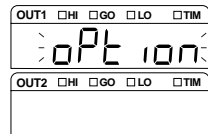

- 2** Press the **[ENT]** key, and select the function "[-]" with the **[▶]** key.

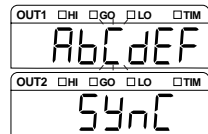

Set the synchronization/asynchronization of the external timing.

- 3** Press the **[ENT]** key, and select "[-] -" with the **[▲]** key.  
"Synchronous" is selected in this example.

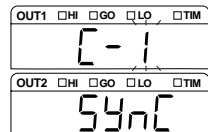

- 4** Press the **[ENT]** key to register the setting. Press the **[SET]** key to return to the measurement state.

#### Reference

Refer to "Chapter 4 Input/Output Terminals" (page 4-1).

## Setting the Output Form of the Tolerance Comparator

The output form of the tolerance comparator can be set. The following three types are available.

Function No.	Output form	Function
d-0 nor $\bar{n}$ PL	Normal	Outputs according to the tolerance comparator.
d-1 Hold	HOLD	Holds the output that is turned ON. Releases the holding when the measurement value is reset.
d-2 dELAY	Off-delay	Off-delay of 60ms is applied to the Normal output. Releases the holding when the setting value is reset.

### ■ Setting the output form of the tolerance comparator

- 1 Hold down the  key, and select "aPl, on" with the  key.

Set the common settings.

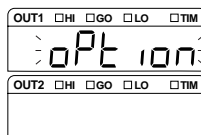

- 2 Press the  key, and select the function "d" with the  key.

Set the output form of the tolerance comparator.



- 3 Press the  key, and select "d-1" with the  key.

"Hold" is set in this example.

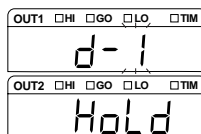



- 4 Press the  key to register the setting. Press the  key to return to the measurement state.

## Setting the Strobe Output Time



The period of time for the strobe output to turn ON (one-shot output time) can be set. The pulse width can be selected from the following four types.

Function No.	Function (Strobe output time)
E-0 2	2 ms
E-1 5	5 ms
E-2 10	10 ms
E-3 20	20 ms



 Refer to "Timing Chart" (4-12 page) for the timing chart.

 Refer to "Binary output" (4-15 page) for details of binary output.

### ■ Setting procedure of the pulse width of the strobe signal

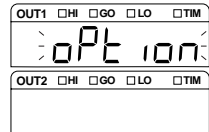

- 1** Hold down the  key, and select "oP t, on" with the  key.  
Set the common settings.



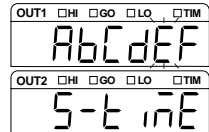

- 2** Press the  key, and select the function "E" with the  key.

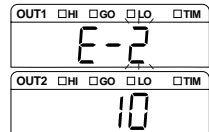

The pulse width of the strobe signal is set.

- 3** Press the  key, and select "E-2" with the  key.  
Set the pulse width to "10" ms.



- 4** Press the  key to register the setting. Press the  key to return to the measurement state.

#### ▶ Note

If the Measurement Mode is set to normal, the strobe signal is output for the specified period only when the measurement value is held. If the measurement value is not held, the strobe signal is output for half the period of sampling cycle.

### Accumulating the Measurement Value in the Memory (Data Storage Function)

Up to 131072 measurement values of OUT1 and OUT2 (65536 values for each OUT1 and 2) can be stored in the internal memory for every accumulation rate. The accumulated data can be read by using the "RS-232C interface" or "LK-Navigator".

The setting contents of the function No. and the sub-function are as follows.

Function No.	Selection of the accumulated data
<i>F-d0 OFF</i>	Does not accumulate data.
<i>F-d1 OUT1</i>	Accumulates the data of OUT 1
<i>F-d2 OUT2</i>	Accumulates the data of OUT 2
<i>F-d3 OUT1&amp;2</i>	Accumulated the data of both OUT1 and 2

Sub-function	Accumulation rate selection
<i>F-F0 1</i>	x 1 (Sampling cycle)
<i>F-F1 2</i>	x 2
<i>F-F2 5</i>	x 5
<i>F-F3 10</i>	x 10
<i>F-F4 20</i>	x 20
<i>F-F5 50</i>	x 50
<i>F-F6 100</i>	x 100
<i>F-F7 200</i>	x 200
<i>F-F8 500</i>	x 500
<i>F-F9 000</i>	x 1000

#### Reference

- The data to be accumulated is the measurement value of OUT1 or of OUT2 after data processing such as the one in the measurement mode. (  page 3-2)
- The accumulating operation stops when the number of accumulated data exceeds the specified number.
- The accumulation time can be calculated by "sampling rate x accumulation rate x number of data".
- The data is accumulated at the sampling rate even when the refresh rate is longer than the sampling rate, which is set in the setting of the average number of times. In such a case, the same measurement value continues to be accumulated until the measurement value is updated.
- The accumulation continues without clearing the accumulated data even if [Auto-zero] or [RESET] is performed.
- When the starting and finishing operation are repeated, the new data is accumulated after the old data.

#### Starting/finishing the accumulation and clearing the data

Conditions for starting the accumulation	<ul style="list-style-type: none"> <li>• Start command from the RS-232 interface.</li> <li>• Operation from the setup support software "LK-Navigator".</li> </ul>
Conditions for finishing the accumulation	<ul style="list-style-type: none"> <li>• Stop command from the RS-232 interface</li> <li>• Operation from the setup support software "LK-Navigator".</li> </ul>
Conditions for clearing the accumulated data	Following operations while stopping the accumulation <ul style="list-style-type: none"> <li>• When moving to the measurement mode from the setting mode or communication mode</li> <li>• When initialization command is sent from the RS-232 interface</li> <li>• Initializing operation from the setup support software "LK-Navigator"</li> <li>• When the power is turned off</li> <li>• When the program No. is changed</li> </ul>



### ■ Setting procedure of the method to accumulate data

- 1** Hold down the **SET** key, and select "OPt ion" with the **▲** key.

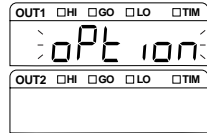

- 2** Press the **ENT** key, and select the function "F" with the **▶** key.



Select data storage.

- 3** Press the **ENT** key, and set the data to accumulate with the **▲** key.

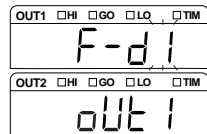

"OUT 1" is set in this example.

- 4** Press the **ENT** key, and set the number of data to accumulate with the **▶** and **▲** keys.



The number of data is set as "1000" in this example.

- 5** Press the **ENT** key, and set the accumulation rate with the **▲** key.

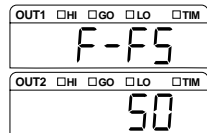

"50" times is set in this example.

- 6** Press the **ENT** key to register the setting. Press the **SET** key to return to the measurement state.

# Setting the Operations of the Equipment (Environment Settings)

This section describes the operation settings of the equipment.

## List of Functions and Function Nos.

3

The following five types of setting are available for the Environment settings. The function and setting value of each type is shown below.

Function	Function	Function No.					Reference page
	Function display	0	1	2	3	4	
<i>R</i>	RS-232C	Baud rate					3-49
	<i>rS232</i>	<b>9600</b>	<i>19200</i>	<i>38400</i>	<i>57600</i>	<i>115200</i>	
		Parity					
		<i>EvEn</i>	<i>odd</i>	<b>non</b>			
		Auto transmission					
		<b>oFF</b>	<i>oUt 1</i>	<i>oUt 2</i>	<i>oUt i2</i>		
<i>b</i>	Setting Selection	Panel	Terminal input				3-50
	<i>CHAnGE</i>	<i>PRnEL</i>	<i>EiU</i>				
<i>l</i>	Program	Copy	Initialization				3-51
	<i>PrG</i>	<i>CoPY</i>	<i>ErRSE</i>				
<i>d</i>	Panel lock	OFF	ON				3-53
	<i>LoCK</i>	<b>oFF</b>	<i>on</i>				
<i>E</i>	Eco mode	OFF	Eco-half	Eco-all			3-54
	<i>ECo</i>	<b>oFF</b>	<i>HALF</i>	<i>ALL</i>			

\* The shaded cells are set by default.

## List of Default Values and Setting Ranges

The function settings (default) at the time of shipment and the settable ranges are as follows.

Function	Item	Settable range	Default value	Remarks
<b>R</b>	Baud rate	9600/19200/38400/57600/115200 bps	9600 bps	
	Parity	NON/EVEN/ODD	NON	
	Auto transmission	OFF/OUT1/OUT2/OUT1.2	OFF	
<b>b</b>	Setting Selection	Panel operation/external terminal	Panel operation	
<b>ℓ</b>	Program	Copy/initialization		
<b>d</b>	Panel lock	ON/OFF	OFF	
<b>E</b>	Eco mode	None/Eco-half/Eco-all	None	

List of the Environment Setting Screens

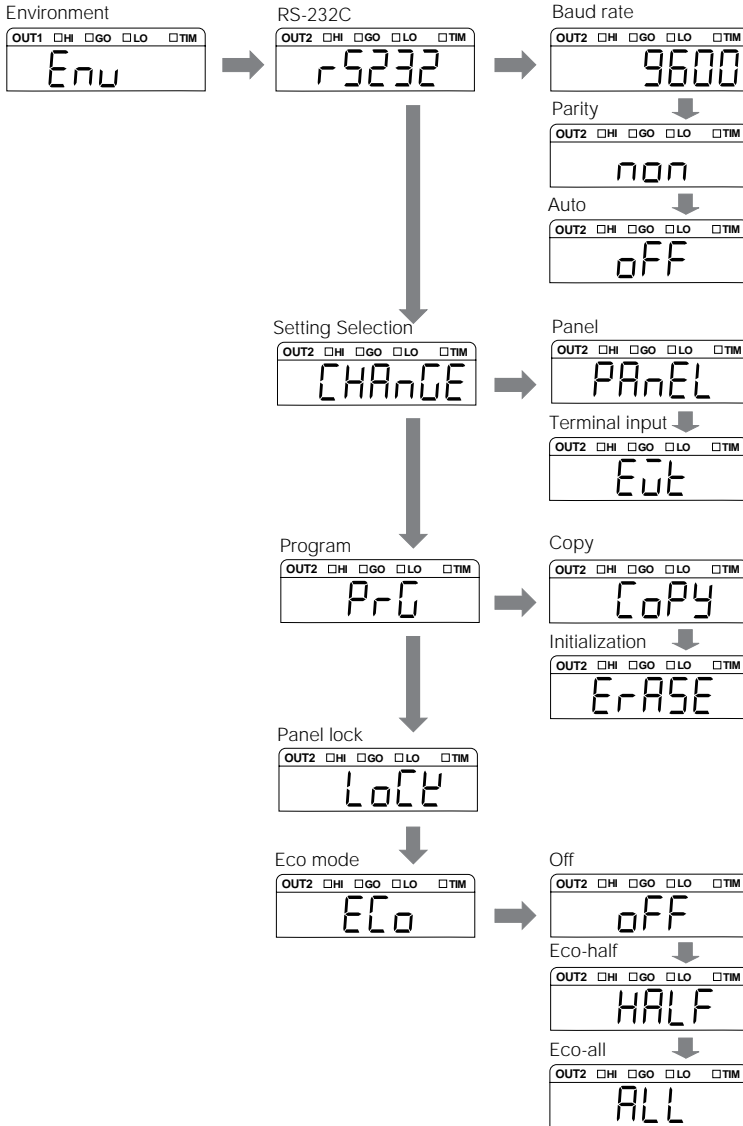

3

## Setting the Communication Specifications of the RS-232C

The communication specifications and the output operations of the RS-232C interface are set.

 Refer to "Chapter 5 RS-232C" (page 5-1). for RS-232C.

Function No.	Setting content	Selection Item	Remarks
R-b0 to R-b4	Sets the communication speed of the data.	9600/19200/38400/57600/ 115200	Unit: bps
R-P0 to R-P2	Sets the type of parity.	None (NON)/Even (EVEN)/ Odd (ODD)	
R-50 to R-53	Auto transmission	OFF/OUT1/OUT2/OUT1.2	



3

### ■ Setting procedure of the communication specifications of the RS-232C

- 1** Press the  key, and select "Env" with the  key.

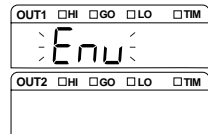
Set the environment settings.



- 2** Press the  key, and select the function "R" by the  key.

Set the output conditions and the output performance of the RS-232C.



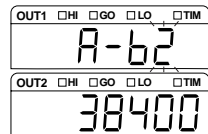

- 3** Press the  key, and select "R-b2" with the  key.

The baud rate is set as "38400 bps" in this example.



- 4**  Set the parity and auto transmission in the same manner.

- 5** Press the  key to register the setting. Press the  key to return to the measurement state.

## Setting the Program Switching Method

Whether the program No. is switched from the display panel or from the external terminal input is set.

Function No.	Setting Selection	Function
b-0 PANEL	Panel	Panel operation/RS-232C
b-1 EXT	Terminal input	External terminal input

3

### Setting procedure of the program switching method

- 1** Press the **SET** key, and select "ENV" with the **▲** key.

Set the environment settings.

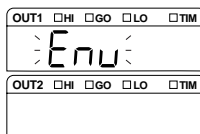

- 2** Press the **ENT** key, and select the function "b" with the **▶** key.

Set the program switching method.



- 3** Press the **ENT** key, and select "b-0" with the **▲** key.

The operation from the panel is set in this example.

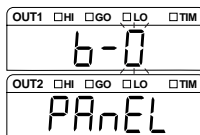

- 4** Press the **ENT** key to register the setting. Press the **SET** key to return to the measurement state.

#### ▶ Note

To switch the program No. by using the command from the RS-232C, set this setting to "Panel operation".

## Copying/Initializing the Program

Copying and initializing of the program are performed.

Function No.	Process	Function
<b>C-0 COPY</b>	Copy	Performs copying by specifying the source program No. and destination program No.
<b>C-1 ERASE</b>	Initialization	Initializes the program of the specified program No.

### ■ Copying procedure of the program

- 1** Press the **SET** key, and select "Enu" with the **▲** key.  
Set the environment settings.

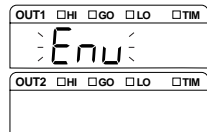

- 2** Press the **ENT** key, and select the function "C" with the **▶** key.  
Perform copying/initialization of the program.



- 3** Press the **ENT** key, and select "C-0" with the **▲** key.  
Copying process of the program starts.

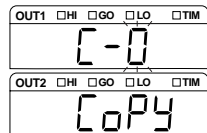

- 4** Press the **ENT** key, and specify the original program No. with the **▲** key.



Program No. 1 is specified as the source in this example.

- 5** Press the **ENT** key, and specify the program No. of the copy destination with the **▲** key.

Program No. 2 is specified as the destination in this example.

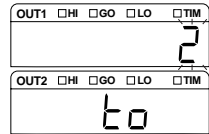

- 6** Press the **ENT** key to check the program Nos. of the copy source and destination.

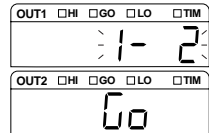

- 7** Press the **ENT** key to perform copying. Press the **SET** key to return to the measurement state.

### ■ Initializing the program

Select the program No. to be initialized beforehand.

Perform the step 1 and 2 of copying procedure of the program.

- 1** Press the **ENT** key, and select "C-1" with the **▲** key.

The initialization process of the program starts.

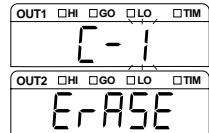

- 2** Press the **ENT** key.

Program No. 3 is initialized in this example.

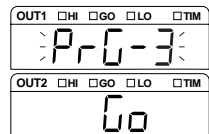

- 3** Press the **ENT** key to initialize. Press the **SET** key to return to the measurement state.



## Preventing Erroneous Operation on the Panel (Panel Lock)

This function is used to prohibit operations on the display panel. Erroneous operations can thus be prevented even if an operation key is mistakenly touched.

Function No.	Panel lock	Function
d-0 OFF	ON	Key operations from the display panel are valid.
d-1 on	Off	Key operations from the display panel are invalid.

### Setting procedure of the panel lock

- 1 Press the SET key, and select "Enu" with the ▲ key.**  
Set the environment settings.
- 2 Press the ENT key, and select the function "d" with the ▶ key.**  
Set the panel lock.
- 3 Press the ENT key, and select "d-1" with the ▲ key.**  
"ON (Lock)" is set in this example.
- 4 Press the ENT key to register the setting. Press the SET key to return to the measurement state.**

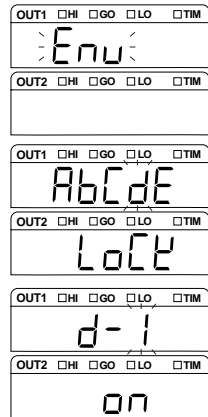

### Canceling the panel lock

- 1 Press the SET key for two seconds or more.**  
The setting screen of the panel lock is displayed.
- 2 Press the ▲ key, and select "d-0".**  
Release the lock.
- 3 Press the ENT key to register the setting. Press the SET key to return to the measurement state.**

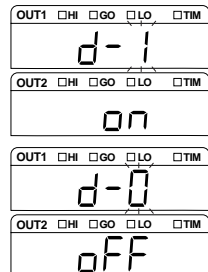

## Reducing the Power Consumption (Eco Mode)

The power consumption can be reduced by turning off the display on the controller.

The Eco mode is activated in 10 seconds after the last key operation during the measurement mode.

The normal mode returns when any key is pressed.

The Eco mode has the following types.

Function No.	Function	Judgment output LED Timing LED	Measured value display LED	Head status display LED*
E-0 OFF	Eco-off	On	On	On
E-1 HALF	Eco-half	On	Off	On
E-2 ALL	Eco-all	Off	Off	Off

\* The LASER ON LED is out of the effect of the Eco mode.

### ■ Setting procedure of the Eco mode

- 1** Press the **SET** key, and select "ENV" with the **▲** key.

Set the environment settings.

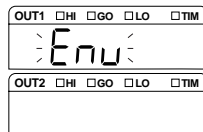

- 2** Press the **ENT** key, and select the function "E" with the **▶** key.

Set the Eco mode.

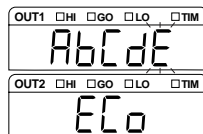

- 3** Press the **ENT** key, and select "E-1" with the **▲** key.

"Eco-half" is set in this example.



- 4** Press the **ENT** key to register the setting. Press the **SET** key to return to the measurement state.

---

# Input/Output Terminals

# 4

This chapter describes the specifications of the input/output terminals and timing chart.

Identifying Names and Functions of the Input/Output Terminals .....	4-2
Timing Chart .....	4-12

# Identifying Names and Functions of the Input/Output Terminals

This section describes the names and functions of the input/output terminals (12-pin I/O terminal block, 6-pin I/O terminal block, and expansion connector).

## Functions of the Input/Output Terminals

This section describes the overview and the functions of the input/output terminals.

4

### 12-pin I/O terminal block

Used for the comparator output and control input of OUT1.  
 Matching cord specification: AWG 28 to 16, length of pigtail cable end fabrication 6.5 mm

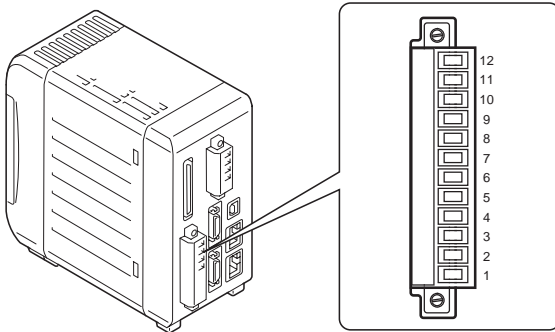

Pin No.	Signal name	Description	
12	COM IN	COM for input	
11	REMOTE	Laser remote interlock input	Non-voltage input (NPN type) Voltage input (PNP type)
10	ZERO1	OUT1 ZERO input	
9	RESET1	OUT1 RESET input	
8	TIMING1	OUT1 TIMING input	
7	COM OUT	COM for output	
6	ALARM 1	OUT1 alarm (N.C.) output	NPN open-collector output (NPN type) PNP open-collector output (PNP type)
5	OUT1 L	OUT1 comparator LO output	
4	OUT1 G	OUT1 comparator GO output	
3	OUT1 H	OUT1 comparator HI output	
2	24 V DC (+)	24 V DC input for power	
1	24 V DC (-)	0 V input for power	



**► Note****• NPN type**

24 V DC (-), COM OUT and COM IN are all common via a choke coil. Also, they are common to 0 V of the 6-pin I/O terminal and COM of the expansion connector via a choke coil. Be careful not to generate a potential difference.

**• PNP type**

24 V DC (-), COM OUT and COM IN are all common via a choke coil. Also, they are common to 0 V of the 6-pin I/O terminal and COM IN of the expansion connector via a choke coil. Be careful not to generate a potential difference.

**Reference**

- Refer to  page 4-10 for the electrical specifications.
- Refer to  page 4-12 for the timing chart.

**6-pin I/O terminal block**

Used for the analog monitor output.

Matching cable specification: AWG28 to 16, length of pigtail cable end fabrication 6.5 mm

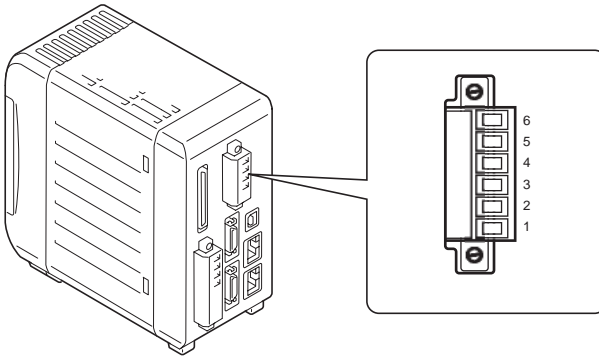

4

Pin No.	Signal name	Description
6	OUT1 (V)	Analog voltage output of OUT1 Outputted in the range of $\pm 10.8$ V with reference to the displayed value.
5	OUT1 (A)	Analog current output of OUT1 Outputted in the range of 3.36 mA to 20.64 mA with reference to the displayed value.
4	OUT1 0V	0V terminal for OUT1
3	OUT2 (V)	Analog voltage output of OUT2 Outputted in the range of $\pm 10.8$ V with reference to the displayed value.
2	OUT2 (A)	Analog current output of OUT2 Outputted in the range of 3.36 mA to 20.64 mA with reference to the displayed value.
1	OUT2 0V	0V terminal for OUT2

\*0 V of pin Nos. 1 and 4 are common.

**Note**

24 V DC (-) for the 12-pin I/O terminal block and 0 V are common via a choke coil. Be careful not to generate a potential difference.

**Reference**

- Refer to page 4-10 for the electrical specifications.
- Refer to page 3-34 for the scaling procedures of the analog output.

## Expansion Connector

Used for the comparator output, control output, and binary output.

Matching connector: FX2B series (HIROSE Electric Inc.)

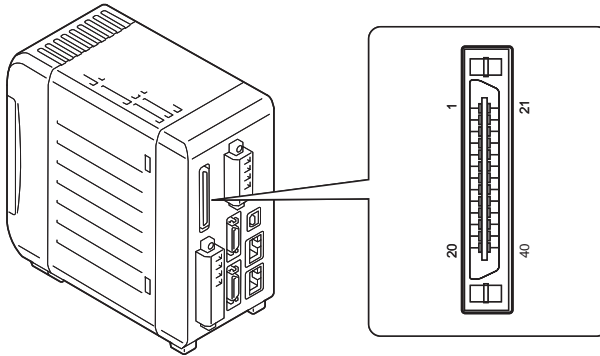

Pin No.	Signal name	Description		Cord color
1	OUT2 comparator HI	OUT2 comparator HI output	NPN open-collector output (NPN type) PNP open-collector output (PNP type)	Brown
2	OUT2 comparator GO	OUT2 comparator GO output		Red
3	OUT2 comparator LO	OUT2 comparator LO output		Orange
4	OUT1 alarm (N.C.)	OUT2 alarm output		Yellow
5	COM OUT	COM for output		Green
6	TIMING2	OUT2 TIMING input	Non-voltage input (NPN type) Voltage input (PNP type)	Blue
7	RESET2	OUT2 RESET input		Purple
8	ZERO2	OUT2 ZERO input		Gray
9	P1	Program No. switch input		White
10	P2		Black	
11	P3		Brown	
12	COM IN	COM for input		Red
13	Binary (0) (LSB)	Binary output	NPN open-collector output (NPN type) PNP open-collector output (PNP type)	Orange
14	Binary (1)			Yellow
15	Binary (2)			Green
16	Binary (3)			Blue
17	Binary (4)			Purple
18	Binary (5)			Gray
19	Binary (6)			White
20	Binary (7)			Black

\* Continues to the next page.

## 4 Input/Output Terminals

Pin No.	Signal name	Description		Cord color
21	Binary (8)	Binary output	NPN open-collector output (NPN type) PNP open-collector output (PNP type)	Brown
22	Binary (9)			Red
23	Binary (10)			Orange
24	Binary (11)			Yellow
25	Binary (12)			Green
26	Binary (13)			Blue
27	Binary (14)			Purple
28	Binary (15)			Gray
29	Binary (16)			White
30	Binary (17)			Black
31	Binary (18)			Brown
32	Binary (19)			Red
33	Binary (20) (MSB)			Orange
34	STROBE			STROBE output
35	OUT1/OUT2 OUT	OUT1/OUT2 selection output	Green	
36	COM OUT	COM for I/O	Blue	
37	OUT1/OUT2 SEL	OUT1/OUT2 selection input	Non-voltage input (NPN type) Voltage input (PNP type)	Purple
38	LASER OFF A	LASER OFF A input		Gray
39	LASER OFF B	LASER OFF B input		White
40	COM IN	COM for I/O	Black	

\* COMs for output of pin Nos. 5 and 36 are common.

\* COMs for input of pin Nos. 12 and 40 are common.

\* The cord color is the wire color of the I/O cable (OP-51657).

### ► Note

#### • NPN type

COM OUT and COM IN are common via a choke coil. Also, 24 V DC (-), COM OUT and COM IN of the 12-pin I/O terminal block are all common via a choke coil. Be careful not to generate a potential difference.

#### • PNP type

COM IN and 24 V DC (-) are common via a choke coil. Also, 24 V DC (-), and COM IN of the 12-pin I/O terminal are common via a choke coil. Be careful not to generate a potential difference.



## Functions of the Input and Output Signals

The following table shows a list of program numbers and how they relate to the status of terminals P1 through P3.

 Refer to 4-2 for the layout of each terminal.

### Comparator output

Name	Description	Reference page
Tolerance comparator output (HI, GO, LO)	Outputted according to the tolerance comparator results.	Page 4-5

### Alarm output

Name	Description	Reference page
Alarm (N.C.) output	Turned on when "-FFFFFF" is displayed due to the alarm processing (the NPN or PNP open-collector output transistor is off). Turned off when the normal value is being held.	Page 4-2

### Input and output signals for measurement control

Name	Description	Reference page
TIMING input	Performs an external synchronization input of the measurement mode.	Page 4-2
RESET input	Resets the measurement value.	Page 4-2

### Auto-zero input

Name	Description	Reference page
ZERO input	Sets the current measurement value to zero.	Page 4-2

### Program No. switch input

Name	Description	Reference page
P1, P2, P3	Changes the program No. by external commands.	Page 4-5

## 4 Input/Output Terminals

The following table shows a list of program numbers and how they relate to the status of terminals P1 through P3 :

Program No.	P3	P2	P1
0	OFF	OFF	OFF
1	OFF	OFF	ON
2	OFF	ON	OFF
3	OFF	ON	ON
4	ON	OFF	OFF
5	ON	OFF	ON
6	ON	ON	OFF
7	ON	ON	ON

Status	NPN type	PNP type
ON	Short-circuit state with the COM terminal	State of voltage applied
OFF	Open state	Open state

When you change the program number via an input/output terminal, [Setting Selection] in the Environment settings should be changed to [Terminal Input].

 Refer to "Setting the Program Switching Method" (page 3-50) for details.

### Binary output

Name	Description	Reference page
Binary output	Outputs the measured value as binary data. Outputs two's complement in 21 bits. Negative logic (1 when the NPN or PNP open-collector output is ON) Comparator standby status (all digits have a negative (-) sign) : 0x100000 Over range at positive side : 0xOFFFFF Over range at negative side : 0x100000 Alarm : 0x100000	Page 4-6
STROBE output	Strobe output of the binary output	Page 4-6
OUT1/OUT2 OUT output	You can identify through which OUT number the data is currently being output. OFF: OUT1 ON: OUT2	Page 4-6
OUT1/OUT2 SEL input	Select the OUT number to output in binary. OFF: OUT1 ON: OUT2	Page 4-6

## Reference

**How to read the binary output**

The LK-G Series outputs the measurement value as a binary number (two's complement) of 21 bits. The decimal point is ignored.

Example: When the measurement value is "+134.97"

- 13497 (decimal) → 0 0000 0011 0100 1011 1001 (binary)

Example 2: When the measurement value is "-134.97"

- -13497 (decimal) → 1 1111 1100 1011 0100 0111 (binary)

**LASER OFF input**

Name	Description	Reference page
LASER OFF input	Controls the laser for each head. For NPN type, the laser is turned off when short-circuited with COM, and turned on when open. For PNP type, the laser is turned off when the voltage is applied, and turned on when the circuit is open. "LASER OFF A" controls the head A, and "LASER OFF B" controls the head B.	Page 4-6

**Laser remote interlock input**

Name	Description	Reference page
REMOTE	This is the laser remote interlock terminal. The laser beam is emitted when the terminal is short-circuited with COM, and emission is stopped when the terminal is open. The terminal is common to head A and B, and takes priority over the LASER OFF input.	Page 4-2

**Electrical specifications for NPN type**

This section describes the electrical specifications and circuit diagram of the input/output terminals.

■ **Non-voltage input**

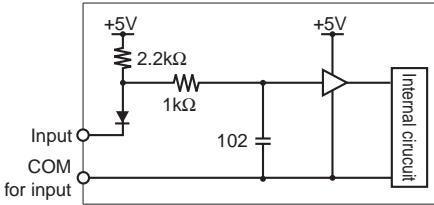

ON voltage	1 V or less
OFF current	0.6 mA or less
Short-circuit current (Typ.)	2 mA

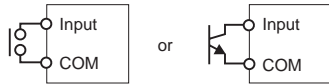

■ **NPN open-collector output**

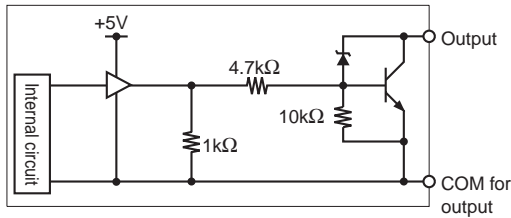

Maximum applied voltage	40 V
Maximum sink current	50 mA
Residual voltage	0.5 V or less
Leakage current	0.1 mA or less

4

## Electrical specifications for PNP type

This section describes the electrical specifications and circuit diagram of the input/output terminals.

### ■ Voltage input

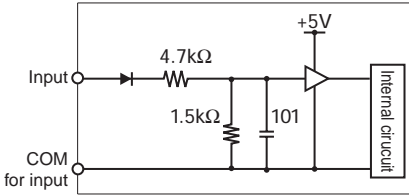

Max. input voltage rating	26.4V
ON voltage	10.2V or more
OFF current	0.6 mA or less
Short-circuit current (Typ.)	2 mA

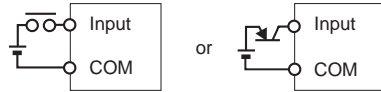

### ■ PNP open-collector output

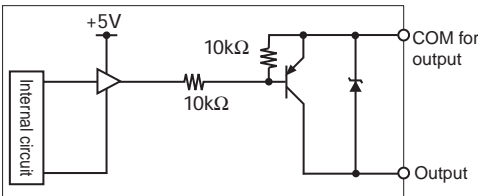

Maximum applied voltage	40 V
Maximum sink current	50 mA
Residual voltage	0.5 V or less
Leakage current	0.1 mA or less

## Electrical specifications common to NPN type and PNP type

### ■ Analog voltage output / analog current output

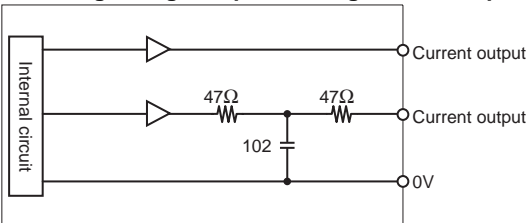

#### Voltage output

Output range	±10.8V (Measurement data: ±10.5 V)
Resolution	2 mV
Accuracy	±0.05% of F.S. (F.S. = 20 V, accuracy with reference to the displayed value)
Output impedance	about 100 Ω
Response Delay Time	about 10 μs (after the measurement value has been updated)

#### Current output

Output range	3.36 to 20.64 mA (Measurement data: 3.6 to 20.4 mA)
Resolution	3 μA
Accuracy	±0.25% of F.S. (F.S. = 16 mA, accuracy with reference to the displayed value)
Matching load	350 Ω max.
Response delay time	about 10 μs (after the measurement value has been updated)

# Timing Chart

This section describes the timing of the input and output signals.

## Normal

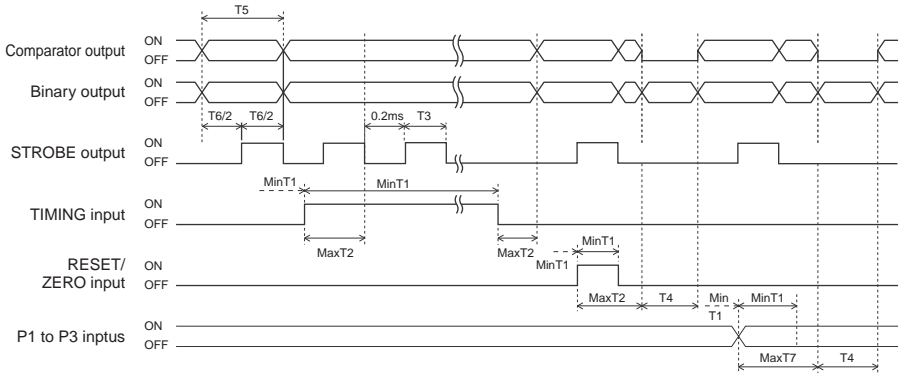

- The minimum input time ( $T_1$ ) is  $600 \mu s$ .
- The input response time ( $T_2$ ), RESET time ( $T_4$ ), refresh rate ( $T_5$ ), sampling rate ( $T_6$ ), and program No. change time ( $T_7$ ) vary depending on the settings.
  - Refer to page 4-17.
- The STROBE time ( $T_3$ ) at the time of hold can be changed.
  - Refer to page 3-43.
- Auto-zero is canceled when the ZERO input is turned on for two seconds or more.
- This is the chart of when the average number of times is 4096. At this time, the refresh rate ( $T_5$ ) equals the sampling rate ( $T_6$ ).
- When the average number of times is 16384, 65536, or 262144, the refresh rate exceeds the sampling rate ( $T_6$ ). However, the STROBE output is outputted at the sampling rate.

## Peak hold/bottom/peak-to-peak hold/average hold/sample hold (trigger 1)

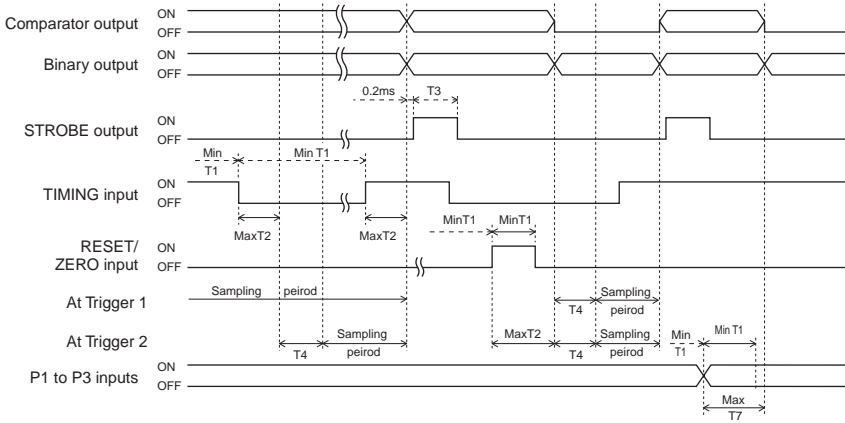

- The minimum input time ( $T_1$ ) is 600  $\mu$ s.
- The input response time ( $T_2$ ), RESET time ( $T_4$ ), and program No. change time ( $T_7$ ) vary depending on the settings.

Refer to page 4-17.

- The STROBE time ( $T_3$ ) can be changed.

Refer to page 3-43.

- Auto-zero is canceled when the ZERO input is turned on for two seconds or more.
- The internal measurement value of the RESET input is determined after the RESET time ( $T_4$ ) has elapsed.

Sample hold (trigger 2)

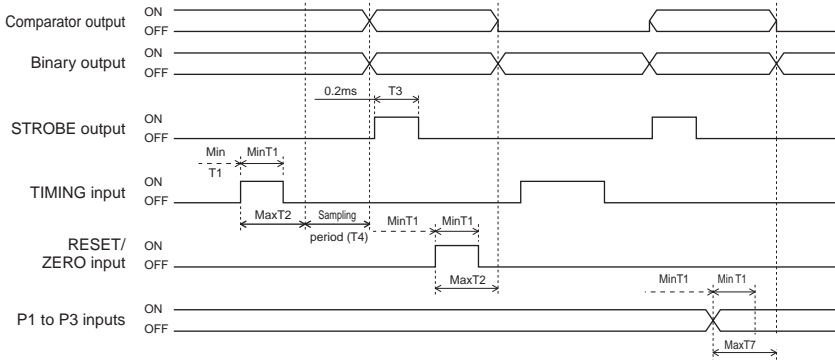

- The measurement value is determined after the sampling period ( $T_4$ ) has elapsed by using the timing input ON as a trigger.
- The minimum input time ( $T_1$ ) is 600  $\mu$ s.
- The input response time ( $T_2$ ), sampling period ( $T_4$ ), and program No. change time ( $T_7$ ) vary depending on the settings.

Refer to page 4-17.

- The STROBE time ( $T_3$ ) can be changed.

Refer to page 3-43.

- Auto-zero is canceled when the ZERO input is turned on for two seconds or more.
- If you turn on the RESET input or the ZERO input during the sampling period, the sampling stops and the comparator standby state is established.



## Binary output

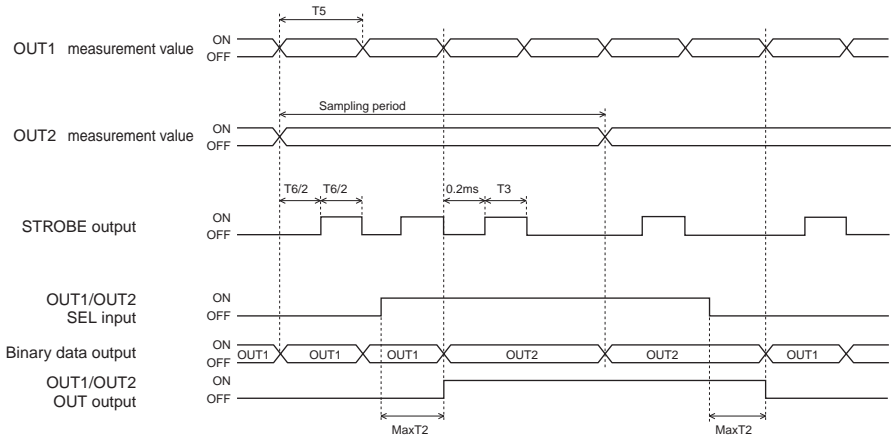

- OUT1 and OUT2 are updated asynchronously depending on the filter settings or the options specified in the measurement mode.
- This timing chart is the example of the state other than OUT1: Normal, and OUT2: Normal.
- Output of either OUT1 or OUT2 can be selected for binary output by "OUT1/OUT2 SEL input".
- You can check whether the present binary output is OUT1 or OUT2 by "OUT1/OUT2 OUT output".
- Synchronize the binary data with the STROBE output signal to import.
- The input response time ( $T_2$ ) and refresh rate ( $T_5$ ) vary depending on the settings.

Refer to page 4-17.

- The STROBE time ( $T_3$ ) can be changed.

Refer to page 3-43.

**LASER REMOTE/LASER OFF**

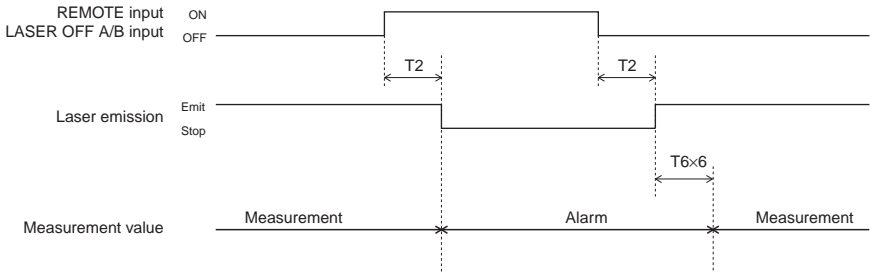

4

\* T6 is a sampling rate. (□ page 3-39)

T2 is the input response time.(□ page 4-17)

The alarm status can be changed with the alarm settings (□ page 3-8).

As for the REMOTE input, the open state is ON, and the short-circuited state is OFF.

As for the LASER OFF A/B input, the open state is OFF, and the short-circuited state is ON for NPN type.

For PNP type, ON when the voltage is applied and OFF for the open state.

## Timing details

### ■ Minimum input time (T1) and input response time (T2)

Sampling rate (T6)	Minimum input time (T1)	Input response time (T2)
20 μs	600 μs	600 μs + T6
50 μs		
100 μs		
200 μs		
500 μs		
1000 μs		

The sampling rate can be changed according to the setting. □ Refer to page 3-39.

The measurement response time, measurement average time, RESET time, and refresh rate vary depending on the sampling rate. Furthermore, when the mutual interference prevention function is turned on, calculate the value after doubling the sampling rate ( $T6 = T6 \times 2$ ).

### ■ Average measurement time, RESET time (T4) and refresh rate (T5)

Filter		Average measurement time	Number of data of moving average	RESET time (T4)	Refresh rate (T5)
Number of data to be averaged	1	$T6 \times 1$	1	$T6 \times 1$	$T6 \times 1$
	4	$T6 \times 4$	1	$T6 \times 4$	$T6 \times 1$
	16	$T6 \times 16$	1	$T6 \times 16$	$T6 \times 1$
	64	$T6 \times 64$	1	$T6 \times 64$	$T6 \times 1$
	256	$T6 \times 256$	1	$T6 \times 256$	$T6 \times 1$
	1024	$T6 \times 1024$	1	$T6 \times 1024$	$T6 \times 1$
	4096	$T6 \times 4096$	1	$T6 \times 4096$	$T6 \times 1$
	16384	$T6 \times 16384$	4	$T6 \times 16384$	$T6 \times 4$
	65536	$T6 \times 65536$	16	$T6 \times 65536$	$T6 \times 16$
	262144	$T6 \times 262144$	64	$T6 \times 262144$	$T6 \times 64$
High-pass filter				$T6 \times 12$	$T6 \times 1$
Low-pass filter				$T6 \times 12$	$T6 \times 1$

When the mutual interference prevention function is turned on, calculate the value after doubling the sampling rate ( $T6 = T6 \times 2$ ).

### ■ Program No. change time (T7)

Number of connecting heads	Sampling rate (T6)	
	20 μs	Other than 20 μs
Single head	60 ms	$(T6 \times 10) + 50$ ms
Two heads	50 ms	$(T6 \times 10) + 60$ ms

When the mutual interference prevention function is turned on, calculate the value after doubling the sampling rate ( $T6 = T6 \times 2$ ).

MEMO

4

---

# RS-232C

# 5

This chapter describes how to connect external devices and the communication functions for external operation.

Specifications .....	5-2
Outputting Measurement Values and Changing Settings through Commands .....	5-4
Outputting Measurement Values in External Synchronization.....	5-22

# Specifications

## Pin Layout

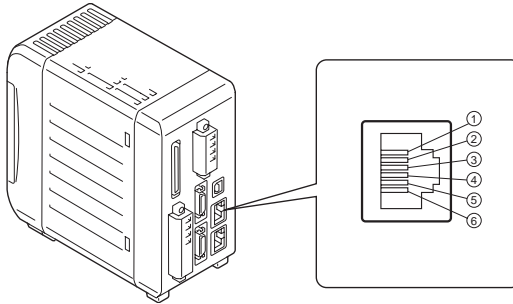

Matching connector specifications: Modular 6-pin plug connector

Pin No.	Terminal name	Description
1	(Not used)	-
2	(Not used)	-
3	SD (TXD)	Receives signal from external devices (input)
4	SG (GND)	GND
5	RD (RXD)	Transmits signal to external devices (output)
6	(Not used)	-

\* Do not use the unused terminal. Doing so may lead to breakdown of the unit.

## Communication Specifications

EIA RS-232C compliant (Modem definition)

Communication method	Full duplex
Synchronization method	Start-stop synchronous
Transmission code	ASCII
Data length	8 bits
Stop bit length	1 bit
Parity check *	None/Even/Odd
Baud rate *	9600/19200/38400/57600/115200 bps
Data delimiter	CR
Flow control	None



\* Refer to "Setting the Communication Specifications of the RS-232C" (page 3-49) for setting the communication specifications.

## Communication Performance and Communication Mode in the Measurement State

Normal mode	During measurement:	Receives the measurement control command. Commands such as for writing or reading the setting values are not accepted.
	During tolerance/function setting	Communication is not accepted. The measurement stops.
Communication mode		<ul style="list-style-type: none"> <li>• [Upon receiving the command [Q], [0] or [CR], the mode changes to the communication mode, and the setting values are written or read.</li> <li>• The measurement stops during the communication mode.</li> </ul>

### ► Note

Complete the series of input or output of commands before moving to the tolerance or function settings from the measurement state.

5

## Overview of the Settings According to External Devices

Perform "Auto transmission settings" according to the external device to be connected as shown in the following table.

Refer to "Setting the Communication Specifications of the RS-232C" (page 3-49).  
For details on usage, refer to the page given in the table.

External device	Auto transmission	Reference page
Non-procedural communication with a PC and a PLC link unit (the communication command is required.)	OFF	"Outputting Measurement Values and Changing Settings through Commands" (page 5-4)
Communication with a PC or a PLC link unit (the measurement value is outputted by being synchronized with the external timing.)	ON	"Outputting Measurement Values in External Synchronization" (page 5-22)

\* "Outputting Measurement Values and Changing Settings through Commands" is also valid when Auto transmission is ON.

# Outputting Measurement Values and Changing Settings through Commands

You can import the measurement value or change the parameters of the LK-G Series by connecting it to a PC or PLC link unit.

## Connecting the PC or PLC Link Unit

Combine the dedicated cables OP-96368 (2.5-m straight cord), OP-26401 (D-sub 9-pin), or OP- 96369 (D-sub 25-pin) for connection.

Refer to the instruction manual of the PC or PLC link unit at the time of connection.

5

Connection diagram

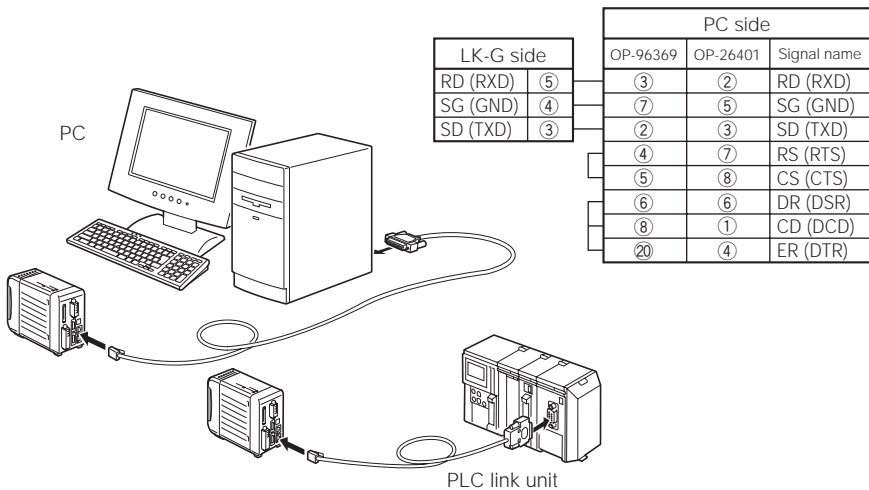

## Environment Settings Parameters

Set the functions according to the PC or PLC link unit to be connected.

Refer to "Setting the Communication Specifications of the RS-232C" (page 3-49).

Item	Setting value	Remarks
Baud rate	9600/19200/38400/57600/115200	Set the parameter according to the external devices to be connected.
Parity check	None/Even/Odd	



## Outline of the command format

The LK-G Series controls the incoming command that has been received and sends back the response command to the external device.

Use [CR] to delimit the data in incoming/response command format.

### ► Note

To create the control program, confirm the response command from the LK-G Series before sending the next command.

### Reference

Both upper-case and lower-case characters can be used in the commands.

The presence or absence of the brackets [ ] in the command format depends on a condition.

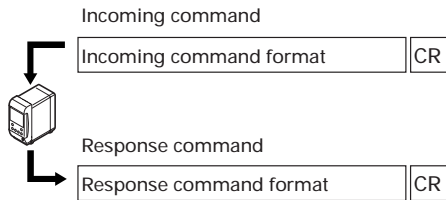

Incoming command format

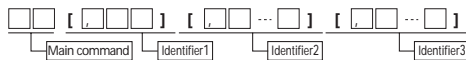

Response command format

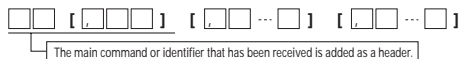

Error response command format

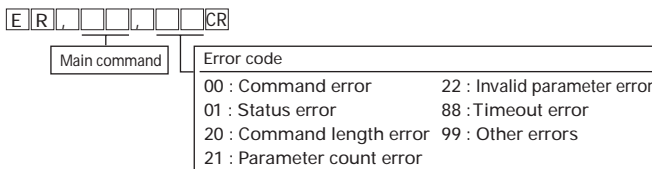

**Measurement value format ( h h h h h h h h )**

The measurement value is outputted in the given format as shown below.



- └ Fixed length data consisting of seven characters. The decimal point is a single character.
- └ The presence/absence and the position of the decimal point vary depending on the settings.
- └ The measurement value is aligned to the right.
- └ Fixed length of a single character: "+" or "-"

The example of the format is shown below.

Display	Output format
+ 1.2345	+ 0 1 . 2 3 4 5
- 0.0120	- 0 0 . 0 1 2 0
+ 1234.56	+ 1 2 3 4 . 5 6
- 1.2	- 0 0 0 0 1 . 2
-----	X X X X X X X X
+ FFFFFFF	+ F F F F F F F
- FFFFFFF	- F F F F F F F

**Setting value format ( f f f f f f f ( f ) )**

The setting change format is the fixed length format that consists of one character and six-digit numerical value. It has no decimal point.

The setting check format is the fixed-length format that consists of one character, six-digit numerical value, and one decimal point.

5

## Mode Change Command

This section describes the command format to switch between the "Normal mode" and "Communication mode".

Refer to page 5-3 for the normal mode and communication mode.

Command list

Operation	Incoming command	Response command
Moving to the communication mode	Q 0 CR	Q 0 CR
Moving to the normal mode	R 0 CR	R 0 CR

### ■ Moving to the communication mode

The mode changes to the communication mode.

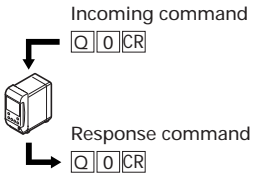

### ■ Moving to the normal mode

The mode changes to the normal mode.

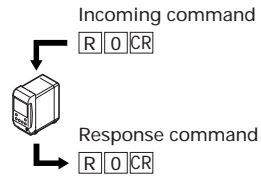

## Measurement Control Command Format

This section describes the command format to control the measurement such as incoming commands that the LK-G Series can receive during the measurement, and the response commands that are to be sent after properly processing the incoming commands.

**► Note**

These commands are accepted only when the controller is in the "Normal mode".

Operation	Incoming command	Response command
Measurement value output	M a CR	M a , h h h h h h h h  [ , h h h h h h h h ]CR
Timing ON/OFF	T p , a CR	T p CR
Auto-zero ON	V a CR	V a CR
Auto-zero OFF	W a CR	W a CR
Reset	V R , a CR	V R CR
Panel lock	K L , p CR	K L CR
Program change	P W , o CR	P W CR
Program check	P R CR	P R , o CR
Statistical result output	D O , a CR	D O , a , h h h h h h h h ,  h h h h h h h h , h h h h h h h h ,  h h h h h h h h , h h h h h h h h ,  m m m m m m m m , m m m m m m m m ,  m m m m m m m m , m m m m m m m m CR
Clearing statistics	D Q , a CR	D Q , a CR
Starting the data storage	A S CR	A S CR
Stopping the data storage	A P CR	A P CR
Initializing the data storage	A Q CR	A Q CR
Outputting the data storage data	A O , a CR	A O [ , h h h h h h h h ] [ , h h h h h h h h ] ⋮ [ , h h h h h h h h ]CR
Data storage accumulation status output	A N CR	A N , s , d d d d d , d d d d d CR

The shaded  cells indicate the setting values or measurement values.

Symbol		
a : OUT number	dddd : Number of the accumulated data	hhhhhhh : Measurement value
p : ON/OFF setting	mmmmm : Number of data	o : Program No.      s : Accumulation status

5

## Command details

This section describes the details of the incoming commands and the responses that are sent when the incoming commands are properly processed.

Refer to "Outline of the command format" (page 5-5) for the response command when an abnormality has occurred.

Refer to "Timing Chart" (page 5-21) for the response delay time of the response command.

### ■ Measurement value output

Outputs a measurement value.

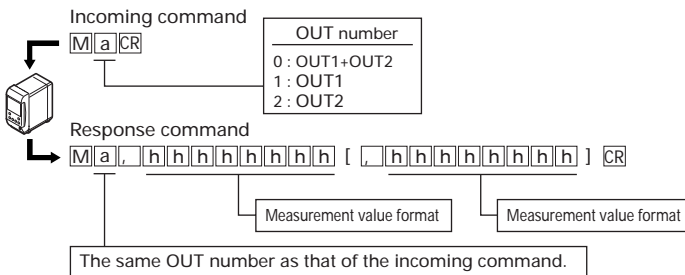

### ■ Timing ON/OFF

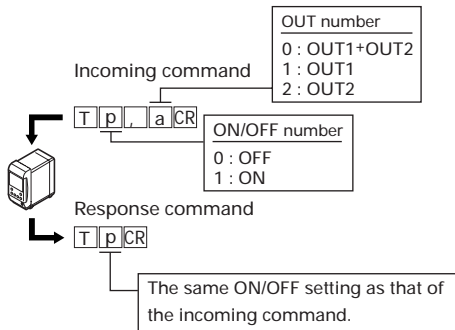

■ Auto-zero ON/OFF

Sets/cancels the Auto-zero function. Auto-zero ON is valid even when the auto-zero is ON, and the reference value is reacquired. Auto-zero OFF is ignored when the auto-zero is OFF.

● Auto-zero ON

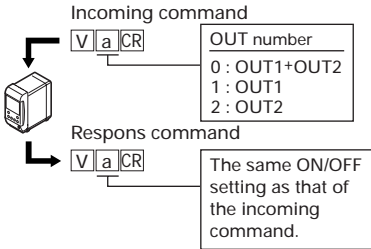

● Auto-zero OFF

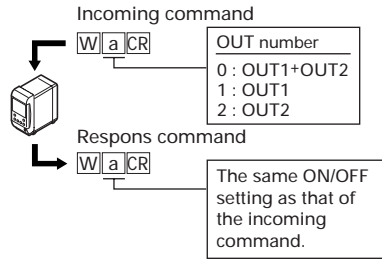

5

■ RESET

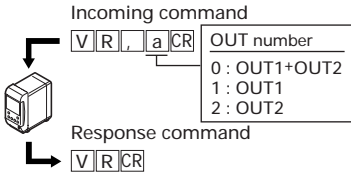

■ Panel lock

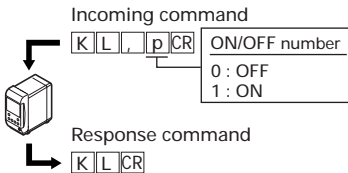



■ Data storage

- Starting the data storage

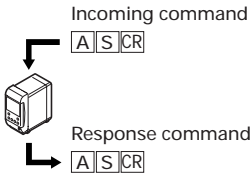

- Stopping the data storage

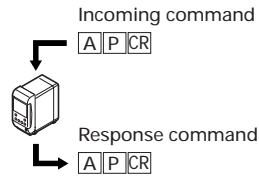

- Initializing the data storage

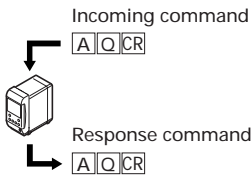

- Outputting the data storage data

Acquires the data accumulated in the data storage.  
When the number of data is zero, only the main command is returned.

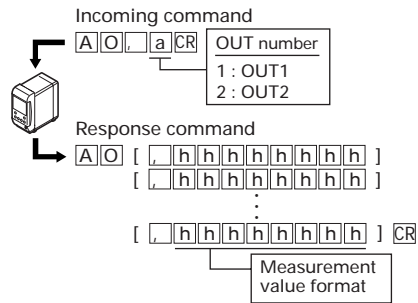

- Data storage accumulation status output

Confirms the accumulation performance of data storage, and acquires the number of the accumulated data.

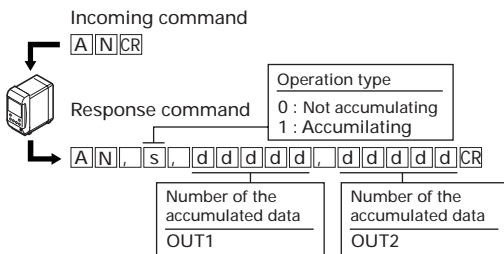

5



## Change Parameter Command

### ► Note

These commands are accepted only when the controller is in the "Communication mode".

Operation		Incoming command	Response command
Display panel switch		D C , a CR	D C CR
Tolerance setting		S W , L M , a , f f f f f f f f , f f f f f f f f , O f f f f f f f f CR	S W , L M CR
Head settings	ABLE	S W , H A , M , h , m CR	S W , H A CR
	ABLE control range	S W , H A , R , h , x x , x x CR	S W , H A CR
	Measurement mode	S W , H B , h , c CR	S W , H B CR
	Number of times of alarm processing	S W , H C , N , h , n n n CR	S W , H C CR
	Alarm level	S W , H C , L , h , c CR	S W , H C CR
	Starting the ABLE calibration	S W , H D , S , h CR	S W , H D CR
	Finishing the ABLE calibration	S W , H D , P CR	S W , H D CR
	Stopping the ABLE calibration	S W , H D , C CR	S W , H D CR
	Mounting mode	S W , H E , h , c CR	S W , H E CR
OUT settings	Calculation method	S W , O A , a , c , c CR	S W , O A CR
	Scaling	S W , O B , y , f f f f f f f f , f f f f f f f f , f f f f f f f f CR	S W , O B CR
	Filter	S W , O C , a , c , c CR	S W , O C CR
	Trigger mode	S W , O E , M , a , c CR	S W , O E CR
	Offset	S W , O F , a , f f f f f f f f CR	S W , O F CR
	Analog output scaling	S W , O H , a , f f f f f f f f , f f f f f f f f , f f f f f f f f CR	S W , O H CR
	Measurement mode, minimum display unit, analog-through	S W , O e , a , c CR	S W , O e CR
Common settings	Data storage	S W , C I , o , d d d d d , i CR	S W , C I CR
	Sampling rate, mutual interference prevention, timing synchronization, comparator output form, strobe time	S W , C e , c CR	S W , C e CR

The shaded  cells indicate the setting values or measurement values.

Symbol			
a : OUT number	c : Function No.	dddd : Number of data	e : Function code
fffff : Setting value	h : Head No.	i : Data interval	m : Mode
nnn : Numerical value without code	o : Data setting		p : Program No.
xx : Control range	y : OUT and head numbers		



■ **ABLE**

Sets ABLE.

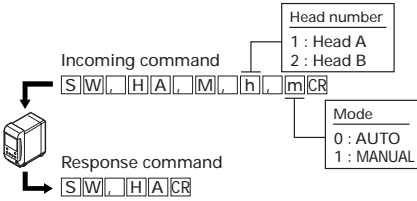

■ **ABLE control range**

Sets the control range of ABLE.

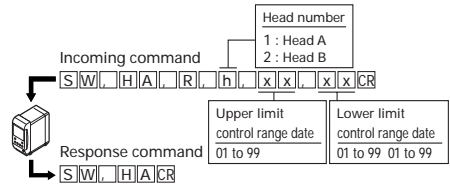

■ **Measurement mode**

Sets the measurement mode.

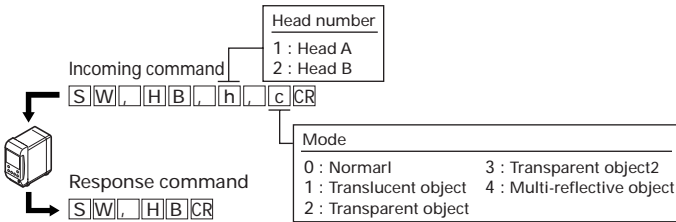

■ **Number of times of alarm processing** ■ **Alarm level**

Sets the number of times of alarm processing. Sets the level of alarm.

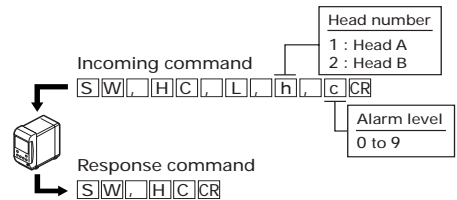
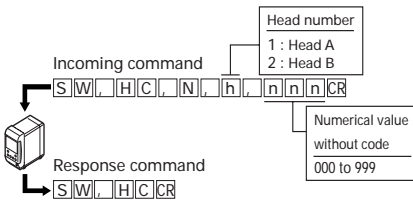

5

■ Starting the ABLE calibration

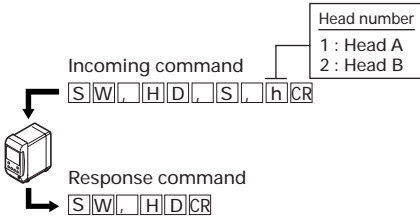

■ Finishing the ABLE calibration

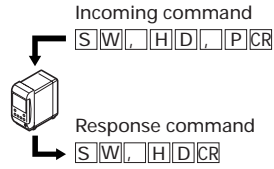

■ Stopping the ABLE calibration

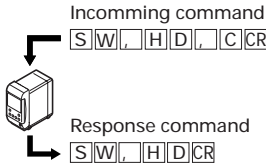

■ Mounting mode

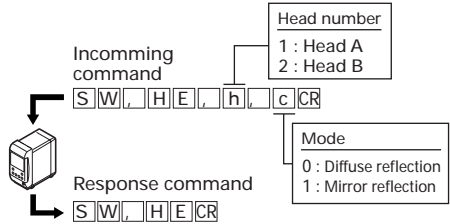

5

■ Calculation method

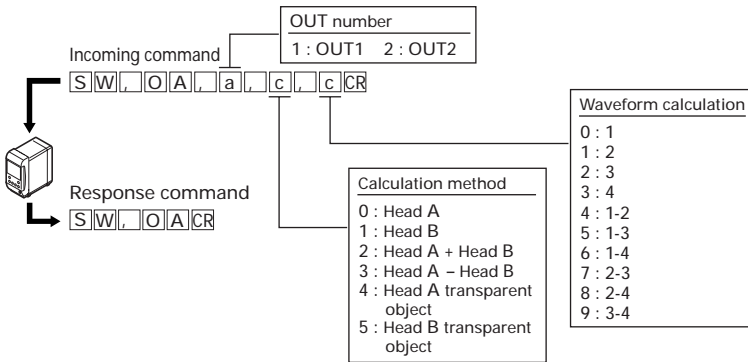

\* Even when specifying a value from 0 to 3 for the calculation method, specify dummy data for the calculation between waveforms.

■ Scaling

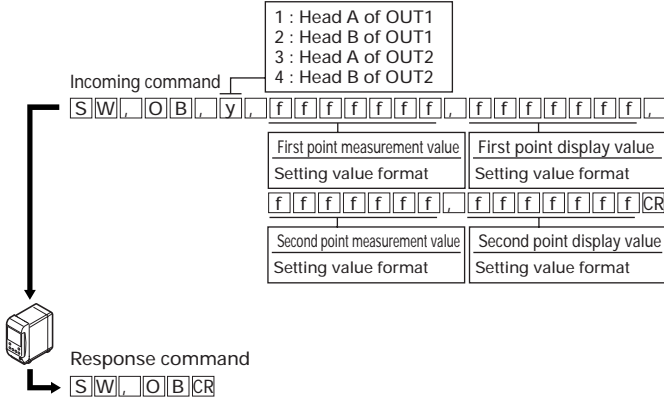

5

■ Filter

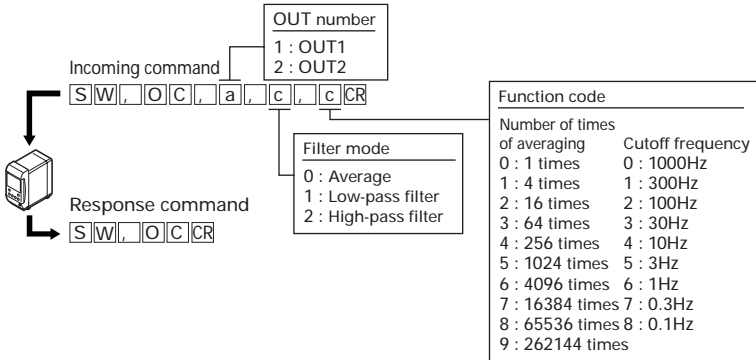

■ Trigger mode

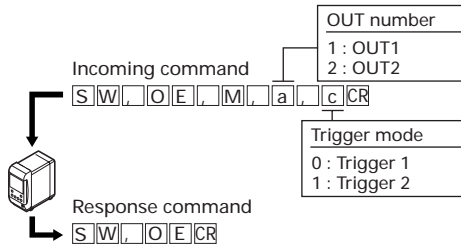

■ Offset

5

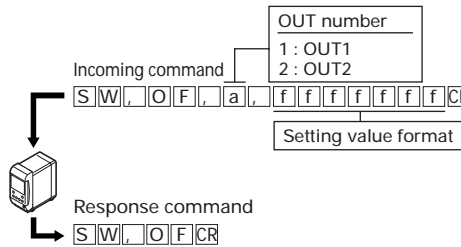

■ Analog output scaling

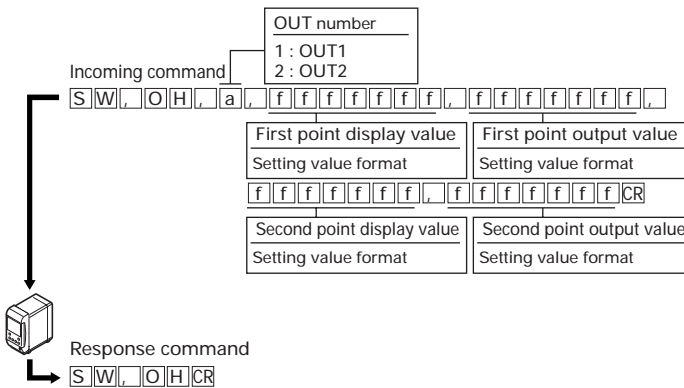

\* Set the voltage value in mV for the setting value format of the output value.

(Setting example) +10.000 V is specified as `+ 0 1 0 0 0 0`

■ Measurement mode, minimum display unit, and analog-through

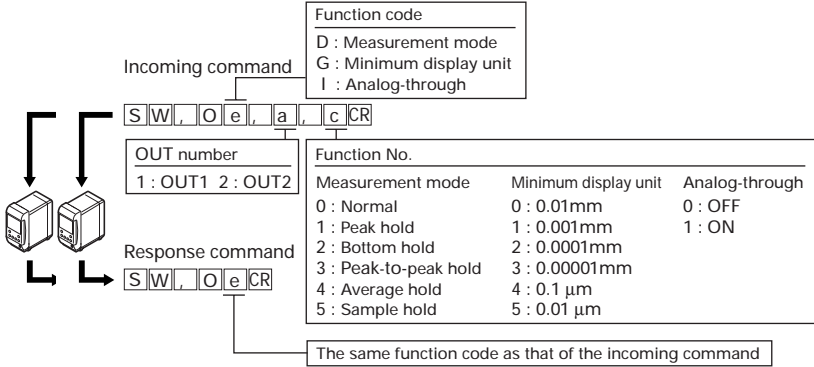

■ Data storage

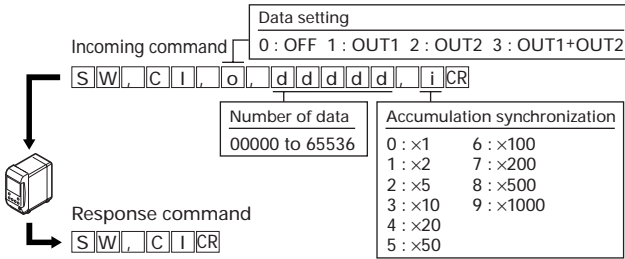

■ Sampling rate, mutual interference prevention, timing synchronization, comparator output form, and strobe time

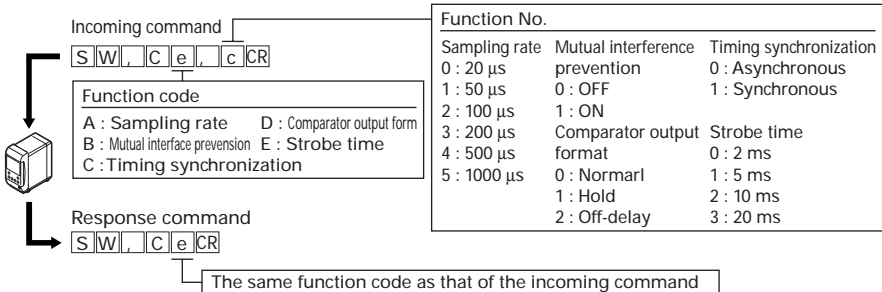





## Timing Chart

The timing chart of the incoming/response command is shown below.

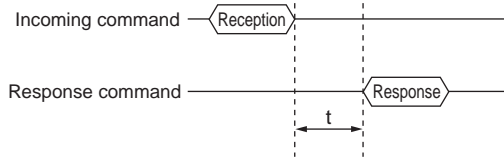

The t-time is identified as follows.

[ms]

Command		Sampling rate (T)		
		20 $\mu$ s	Other than 20 $\mu$ s	
Measurement control	M	8	2	
	PW	When connecting one head	60	$(T \times 10) + 50$
		When connecting two heads	50	$(T \times 10) + 60$
	DO	20	5	
	Other than above	10	3	
Setting/check	S W , H D	60		
	Other than above	5		
Mode change	Q0	5		
	R0	70		

\* The response speed slows during the communication with the Setup support software "LK-Navigator".

# Outputting Measurement Values in External Synchronization

This section describes how to synchronize the measurement value with the measurement performed by the commands from the input terminal (TIMING input) and output it from the RS-232C interface.

**This method does not use any incoming command, so it is used when the measurement value is only imported or when the unit is connected to a device such as a data logger that cannot send a command.**

## Reference

Commands for measurement value output and for setting change are available even when the measurement value output is in use in external synchronization (when the external trigger input is other than OFF).

## Note

Do not fix the next measurement value while the current measurement value is outputted via RS-232C. That next measurement value will not be outputted.

## Environment Settings Parameters

Set the environment settings as follows.

 Refer to "Setting the Communication Specifications of the RS-232C" (page 3-49) for Environment settings.

Item	Setting value	Remark
Baud rate	9600/19200/38400/57600/115200 bps	Set the parameter according to the external devices to be connected.
Parity check	None/Even/Odd	
Auto transmission	OUT1/OUT2/OUT1 + OUT2	Select one of them according to the output method.

## Output

The measurement value that is fixed in the external synchronization (TIMING1 and 2 input) is outputted.

The output content becomes as follows depending on the setting of auto transmission.

Auto transmission	Output contents
OFF	Does not output the measurement values in external synchronization.
OUT1	Outputs only OUT1.
OUT2	Outputs only OUT2.
OUT1 + OUT2	Outputs OUT1 and OUT2 at the same time.

## Timing Chart

### ■ When the measurement mode is other than sample hold (trigger 2)

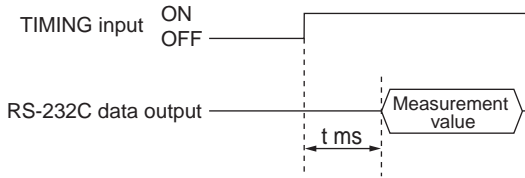

- When the measurement mode is set to normal, the measurement value of when the timing input turns on is outputted.
- When the measurement mode is peak hold, bottom hold, peak-to-peak hold, average hold or sample hold (trigger 1), the measurement value that is fixed by turning on the timing input is outputted.

### ■ When the measurement hold is sample hold (trigger 2)

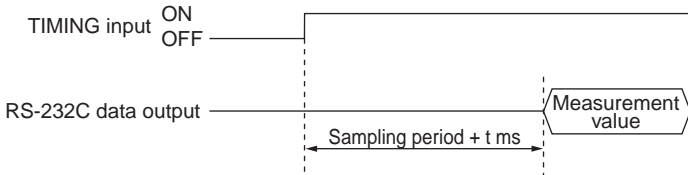

- After the timing input turns on, the measurement value fixed after the sampling period + t ms is outputted.

The t-time is identified as follows.

Sampling rate	20 $\mu$ s	$t = T_2 + 4$ ms
	Other than 20 $\mu$ s	$t = T_2 + 3$ ms

Refer to page 4-16 for  $T_2$  (input response time).

## Output Format

The command format of the measurement value output is identified as follows.  
 Regardless of the setting of the timing synchronization, the fixed measurement value of each OUT number is outputted in this format.

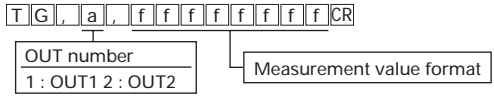

## ASCII Code Table (Reference)

5

		First 4 bit							
		0	1	2	3	4	5	6	7
Last 4 bit	0	N <sub>U</sub> L	D <sub>E</sub> S	0	@	P	`	p	
	1	S <sub>O</sub> H	D <sub>C</sub> 1	!	1	A	Q	a	q
	2	S <sub>T</sub> X	D <sub>C</sub> 2	"	2	B	R	b	r
	3	E <sub>T</sub> X	D <sub>C</sub> 3	#	3	C	S	c	s
	4	F <sub>O</sub> T	D <sub>C</sub> 4	\$	4	D	T	d	t
	5	E <sub>N</sub> O	N <sub>A</sub> K	%	5	E	U	e	u
	6	A <sub>C</sub> K	S <sub>Y</sub> N	&	6	F	V	f	v
	7	B <sub>E</sub> L	E <sub>T</sub> B	'	7	G	W	g	w
	8	B <sub>S</sub>	C <sub>A</sub> N	(	8	H	X	h	x
	9	H <sub>T</sub>	E <sub>M</sub> )	)	9	I	Y	i	y
	A	L <sub>F</sub>	S <sub>U</sub> B	*	:	J	Z	j	z
	B	V <sub>T</sub>	E <sub>S</sub> C	+	;	K	[	k	{
	C	F <sub>F</sub>	→	,	<	L	¥	l	
	D	C <sub>R</sub>	←	-	=	M	]	m	}
	E	S <sub>O</sub>	↑	.	>	N	^	n	~
	F	S <sub>I</sub>	↓	/	?	O	_	o	D <sub>T</sub>

---

# Specifications of the LK-G Series

# 6

This chapter describes the specifications of the controller and the head, outside dimensions, and characteristics such as spot diameter.

Specifications .....	6-2
Characteristics .....	6-21

# Specifications

## Specifications of the Controller

Model	Single unit type	LK-G3001V	LK-G3001VP
	Separate type *1	LK-G3001/LK-GD500	LK-G3001P/LK-GD500P
Head compatibility		Compatible	
Connectable number of heads		Two heads max.	
Display	Minimum display unit	0.01 $\mu\text{m}$	
	Display range	$\pm 9999.99$ mm to $\pm 9999.99$ $\mu\text{m}$ (selectable from six steps)	
	Display cycle	10 times/sec.	
Terminal block	Analog voltage output	$\pm 10$ V x 2 outputs, output impedance 100 $\Omega$	
	Analog current output	4 to 20 mA x 2 outputs, maximum load resistance 350 $\Omega$	
	Timing input	Non-voltage input for OUT1	Voltage input for OUT1
	Reset input		
	Auto-zero input		
	Laser remote interlock input	Non-voltage input	
	Comparator output	NPN open-collector output for OUT1	PNP open-collector output for OUT1
	Alarm output	NPN open-collector output for OUT1 (N.C.)	PNP open-collector output for OUT1 (N.C.)
Optional Connector	Timing input	Non-voltage input for OUT2	Voltage input for OUT2
	Reset input		
	Auto-zero input		
	Program switch input	Non-voltage input x 3 inputs	Voltage input x 2 inputs
	Laser OFF input	Non-voltage input for head A/head B	Voltage input for head A/ head B
	Comparator output	NPN open-collector output for OUT2	PNP open-collector output for OUT2
	Alarm output	NPN open-collector output for OUT2 (N.C.)	PNP open-collector output for OUT2 (N.C.)
	Binary	Binary output	Measurement data output (21 bits) OUT1/OUT2 selectable NPN open-collector output
Strobe output		NPN open-collector output	PNP open-collector output
Binary selection output		NPN open-collector output	PNP open-collector output
Binary selection input		Non-voltage input	Voltage input

Model	Single unit type	LK-G3001V	LK-G3001VP
	Separate type *1	LK-G3001/LK-GD500	LK-G3001P/LK-GD500P
RS-232C interface		Measurement data output and control I/O (selectable up to the baud rate of 115200 bit/s)	
USB interface		USB Revision 2.0, Full speed (USB1.1 compatible) compliant	
Main functions		2-OUT simultaneous measurement function, Calculation function, Averaging function, Filter function, Calibration function, Measurement function, Auto-zero function, Sampling rate setting function, Mutual interference prevention function, Data storage function, 8-program memory function, Eco mode, ABLE setting function, Measurement target setting function, ABLE calibration function, Transparent object measuring surface selection function, Statistical computation function, Setup support software connection function, Head installation selection function, and others	
Rating	Power voltage	24 V DC $\pm$ 10%. Ripple (P-P): 10% max.	
	Maximum current consumption	When connecting one measurement head 500 mA or less/ When connecting two measurement heads 600 mA or less	
Environmental resistance	Operating ambient temperature	0 to +50 °C	
	Operating ambient humidity	35 to 85% RH (No condensation)	
Weight		Approx. 480 g (LK-G3001V/LK-G3001P) Approx. 370 g (LK-G3001/LK-G3001VP)/ Approx. 60 g (LK-GD500)	

\*1 The LK-G3001 can be used independently. The measurement value display and the setting change can be performed on the display panel (LK-GD500) or the Setup support software (LK-H1W).

- The output rating of the NPN open-collector  
50 mA Max. (40 V or less), residual voltage: 0.5 V or less
- The output rating of the PNP open-collector  
50 mA Max. (30 V or less), residual voltage: 0.5 V or less
- Non-voltage input rating  
ON voltage: 1 V or less, OFF current: 0.6 mA or less
- Voltage input rating  
ON voltage: 10.2 V, OFF current: 0.6 mA

## Specifications of the Head

### ■ LK-G35/LK-G30

Model		LK-G35/LK-G30
Setting mode		Diffuse reflection      Regular reflection
Reference distance		30 mm      23.5 mm
Measurement range *3		±5 mm      ±4.5 mm
Light source		Red semiconductor laser
	Wavelength	650 nm (visible light) class 3R (IEC60825-1) class III a (CDRH)
	Output	4.8 mW max.
Spot diameter (at reference distance)		About 30 x 850 μm (G35) About ø30 μm (G30)
Linearity*1		±0.05% of F.S. (F.S. = ±5 mm)
Resolution power *2		0.05 μm (0.01 μm)
Sampling rate		20/50/100/200/500/1000 μs (Selectable among six steps)
LED indication		Near the center of measurement range: Lights in green Within the measurement range: Lights in orange Outside the measurement range: Flashes in orange
Temperature characteristics		0.01% of F.S./°C (F.S. = ±5 mm)
Environmental resistance	Enclosure rating	IP67 (IEC60529)
	Operating ambient light	Incandescent lamp or fluorescent lamp: 10000 lux max.
	Operating ambient temperature	0 to +50 °C
	Operating ambient humidity	35 to 85% RH (No condensation)
	Vibration resistance	10 to 55 Hz, double amplitude 1.5 mm, 2 hours for each of XYZ axes
Material		Aluminum die-cast
Weight (including cable)		Approx. 280 g

\*1 The value when measuring the KEYENCE standard target (ceramic) in the standard mode

\*2 The value when measuring the KEYENCE standard target (SUS) 4096 times average at the reference distance.

The value in parenthesis ( ) indicates the typical value when measured with the number of averaging times of 16384.

\*3 When the sampling rate is 20 μs, the value becomes +1.8 (FAR side) to -5 mm (NEAR side) at the time of the diffuse reflection, and +1.6 (FAR side) to -4.5 mm (NEAR side) at the time of the regular reflection.



### ■ LK-G35H/LK-G30H

Model		LK-G35/LK-G30H	
Setting mode		Diffuse reflection	Regular reflection
Reference distance		30 mm	23.5 mm
Measurement range *3		±5 mm	±4.5 mm
Light source		Red semiconductor laser	
	Wavelength	650 nm (visible light) class 3R (IEC60825-1) class III a (CDRH)	
	Output	4.8 mW max.	
Spot diameter (at reference distance)		About 30 x 850 μm (G35H) About ø30 μm (G30H)	
Linearity*1		±0.05% of F.S. (F.S. = ±5 mm)	
Resolution power *2		0.3 μm	
Sampling rate		20/50/100/200/500/1000 μs (Selectable among six steps)	
LED indication		Near the center of measurement range: Lights in green Within the measurement range: Lights in orange Outside the measurement range: Flashes in orange	
Temperature characteristics		0.01% of F.S./°C (F.S. = ±5 mm)	
Environmental resistance	Enclosure rating	IP67 (IEC60529)	
	Operating ambient light	Incandescent lamp or fluorescent lamp: 10000 lux max.	
	Operating ambient temperature	0 to +50 °C	
	Operating ambient humidity	35 to 85% RH (No condensation)	
	Vibration resistance	10 to 55 Hz, double amplitude 1.5 mm, 2 hours for each of XYZ axes	
Material		Aluminum die-cast	
Weight (including cable)		Approx. 280 g	

\*1 The value when measuring the KEYENCE standard target (ceramic) in the standard mode

\*2 The value when measuring the KEYENCE standard target (SUS) 4096 times average at the reference distance.

\*3 When the sampling rate is 20 μs, the value becomes +1.8 (FAR side) to -5 mm (NEAR side) at the time of the diffuse reflection, and +1.6 (FAR side) to -4.5 mm (NEAR side) at the time of the regular reflection.

### ■ LK-G37/LK-G32

Model		LK-G37/LK-G32	
Setting mode		Diffuse reflection	Regular reflection

## 6 Specifications of the LK-G Series

Model		LK-G37/LK-G32
Reference distance		30 mm      23.5 mm
Measurement range *3		±5 mm      ±4.5 mm
Light source		Red semiconductor laser
	Wavelength	650 nm (visible light) class 2 (IEC60825-1) class II (CDRH)
	Output	0.95 mW max.
Spot diameter (at reference distance)		About 30 x 850 μm (G37) About ø30 μm (G32)
Linearity*1		±0.05% of F.S. (F.S. = ±5 mm)
Resolution power *2		0.05 μm
Sampling rate		20/50/100/200/500/1000 μs (Selectable among six steps)
LED indication		Near the center of measurement range: Lights in green Within the measurement range: Lights in orange Outside the measurement range: Flashes in orange
Temperature characteristics		0.01% of F.S./°C (F.S. = ±5 mm)
Environmental resistance	Enclosure rating	IP67 (IEC60529)
	Operating ambient light	Incandescent lamp or fluorescent lamp: 10000 lux max.
	Operating ambient temperature	0 to +50 °C
	Operating ambient humidity	35 to 85% RH (No condensation)
	Vibration resistance	10 to 55 Hz, double amplitude 1.5 mm, 2 hours for each of XYZ axes
Material		Aluminum die-cast
Weight (including cable)		Approx. 280 g

\*1 The value when measuring the KEYENCE standard target (ceramic) in the standard mode

\*2 The value when measuring the KEYENCE standard target (SUS) 4096 times average at the reference distance.

\*3 When the sampling rate is 20 μs, the value becomes +1.8 (FAR side) to -5 mm (NEAR side) at the time of the diffuse reflection, and +1.6 (FAR side) to -4.5 mm (NEAR side) at the time of the regular reflection.

### ■ LK-G37H/LK-G32H

Model		LK-G37H/LK-G32H	
Setting mode		Diffuse reflection	Regular reflection
Reference distance		30 mm	23.5 mm
Measurement range *3		±5 mm	±4.5 mm
Light source		Red semiconductor laser	
		Wavelength	650 nm (visible light) class 2 (IEC60825-1) class II (CDRH)
		Output	0.95 mW max.
Spot diameter (at reference distance)		About 30 x 850 μm (G37H) About ø30 μm (G32H)	
Linearity*1		±0.05% of F.S. (F.S. = ±5 mm)	
Resolution power *2		0.3 μm	
Sampling rate		20/50/100/200/500/1000 μs (Selectable among six steps)	
LED indication		Near the center of measurement range: Lights in green Within the measurement range: Lights in orange Outside the measurement range: Flashes in orange	
Temperature characteristics		0.01% of F.S./°C (F.S. = ±5 mm)	
Environmental resistance	Enclosure rating	IP67 (IEC60529)	
	Operating ambient light	Incandescent lamp or fluorescent lamp: 10000 lux max.	
	Operating ambient temperature	0 to +50 °C	
	Operating ambient humidity	35 to 85% RH (No condensation)	
	Vibration resistance	10 to 55 Hz, double amplitude 1.5 mm, 2 hours for each of XYZ axes	
Material		Aluminum die-cast	
Weight (including cable)		Approx. 280 g	

\*1 The value when measuring the KEYENCE standard target (ceramic) in the standard mode

\*2 The value when measuring the KEYENCE standard target (SUS) 4096 times average at the reference distance.

\*3 When the sampling rate is 20 μs, the value becomes +1.8 (FAR side) to -5 mm (NEAR side) at the time of the diffuse reflection, and +1.6 (FAR side) to -4.5 mm (NEAR side) at the time of the regular reflection.

■ LK-G15/LK-G10

Model		LK-G15/LK-G10
Reference distance		10 mm
Measurement range *3		±1 mm
Light source		Red semiconductor laser
	Wavelength	650 nm (visible light) class I (IEC60825-1) class II (CDRH)
	Output	0.3 mW max.
Spot diameter (at reference distance)		About 20 x 500 μm (G15) About ø20 μm (G10)
Linearity*1		±0.03% of F.S. (F.S. = ±1 mm)
Resolution power *2		0.02 μm (0.01 μm)
Sampling rate		20/50/100/200/500/1000 μs (Selectable among six steps)
LED indication		Near the center of measurement range: Lights in green Within the measurement range: Lights in orange Outside the measurement range: Flashes in orange
Temperature characteristics		0.01% of F.S./°C (F.S. = ±1 mm)
Environmental resistance	Enclosure rating	IP67 (IEC60529)
	Operating ambient light	Incandescent lamp or fluorescent lamp: 10000 lux max.
	Operating ambient temperature	0 to +50 °C
	Operating ambient humidity	35 to 85% RH (No condensation)
	Vibration resistance	10 to 55 Hz, double amplitude 1.5 mm, 2 hours for each of XYZ axes
Material		Aluminum die-cast
Weight (including cable)		Approx. 190 g

\*1 The value when measuring the KEYENCE standard target (ceramic) in the standard mode

\*2 The value when measuring the KEYENCE standard target (SUS) 4096 times average at the reference distance.

The value in parenthesis ( ) indicates the typical value when measured with the number of averaging times of 16384.

\*3 When the sampling rate is 20 μs, the value becomes +0.37 (FAR side) to -1 mm (NEAR side) at the time of the diffuse reflection.

### ■ LK-G15H/LK-G10H

Model		LK-G15H/LK-G10H
Reference distance		10 mm
Measurement range *3		±1 mm
Light source		Red semiconductor laser
	Wavelength	650 nm (visible light) class I (IEC60825-1) class II (CDRH)
	Output	0.3 mW max.
Spot diameter (at reference distance)		About 20 x 500 μm (G15H) About ø20 μm (G10H)
Linearity*1		±0.03% of F.S. (F.S. = ±1 mm)
Resolution power *2		0.3 μm
Sampling rate		20/50/100/200/500/1000 μs (Selectable among six steps)
LED indication		Near the center of measurement range: Lights in green Within the measurement range: Lights in orange Outside the measurement range: Flashes in orange
Temperature characteristics		0.01% of F.S./°C (F.S. = ±1 mm)
Environmental resistance	Enclosure rating	IP67 (IEC60529)
	Operating ambient light	Incandescent lamp or fluorescent lamp: 10000 lux max.
	Operating ambient temperature	0 to +50 °C
	Operating ambient humidity	35 to 85% RH (No condensation)
	Vibration resistance	10 to 55 Hz, double amplitude 1.5 mm, 2 hours for each of XYZ axes
Material		Aluminum die-cast
Weight (including cable)		Approx. 190 g

\*1 The value when measuring the KEYENCE standard target (ceramic) in the standard mode

\*2 The value when measuring the KEYENCE standard target (SUS) 4096 times average at the reference distance.

\*3 When the sampling rate is 20 μs, the value becomes +0.37 (FAR side) to -1 mm (NEAR side) at the time of the diffuse reflection.

■ LK-G155/LK-G150

Model		LK-G155/LK-G150	
Setting mode		Diffuse reflection	Regular reflection
Reference distance		150 mm	147.5 mm
Measurement range *3		±40 mm	±35 mm
Light source		Red semiconductor laser	
		Wavelength	650 nm (visible light) class 3R (IEC60825-1) class III a (CDRH)
		Output	4.8 mW max.
Spot diameter (at reference distance)		About 120 x 1700 μm (G155) About ø120 μm (G150)	
Linearity*1		±0.05% of F.S. (F.S. = ±40 mm)	
Resolution power *2		0.5 μm	
Sampling rate		20/50/100/200/500/1000 μs (Selectable among six steps)	
LED indication		Near the center of measurement range: Lights in green Within the measurement range: Lights in orange Outside the measurement range: Flashes in orange	
Temperature characteristics		0.01% of F.S./°C (F.S. = ±40 mm)	
Environmental resistance	Enclosure rating	IP67 (IEC60529)	
	Operating ambient light	Incandescent lamp or fluorescent lamp: 10000 lux max.	
	Operating ambient temperature	0 to +50 °C	
	Operating ambient humidity	35 to 85% RH (No condensation)	
	Vibration resistance	10 to 55 Hz, double amplitude 1.5 mm, 2 hours for each of XYZ axes	
Material		Aluminum die-cast	
Weight (including cable)		Approx. 290 g	

\*1 The value when measuring the KEYENCE standard target (ceramic) in the standard mode

\*2 The value when measuring the KEYENCE standard target (SUS) 4096 times average at the reference distance.

\*3 The value when measuring the KEYENCE standard target (ceramic). When the sampling rate is 20 μs, the value becomes -22 (NEAR side) to -40 mm (NEAR side) at the time of the diffuse reflection, and -22 (NEAR side) to -39 mm (NEAR side) at the time of the regular reflection.

### ■ LK-G155H/LK-G150H

Model		LK-G155H/LK-G150H	
Setting mode		Diffuse reflection	Regular reflection
Reference distance		150 mm	147.5 mm
Measurement range *3		±40 mm	±35 mm
Light source		Red semiconductor laser	
		Wavelength	650 nm (visible light) class 3R (IEC60825-1) class III a (CDRH)
		Output	4.8 mW max.
Spot diameter (at reference distance)		About 120 x 1700 μm (G155H) About ø120 μm (G150H)	
Linearity*1		±0.05% of F.S. (F.S. = ±40 mm)	
Resolution power *2		0.6 μm	
Sampling rate		20/50/100/200/500/1000 μs (Selectable among six steps)	
LED indication		Near the center of measurement range: Lights in green Within the measurement range: Lights in orange Outside the measurement range: Flashes in orange	
Temperature characteristics		0.01% of F.S./°C (F.S. = ±40 mm)	
Environmental resistance	Enclosure rating	IP67 (IEC60529)	
	Operating ambient light	Incandescent lamp or fluorescent lamp: 10000 lux max.	
	Operating ambient temperature	0 to +50 °C	
	Operating ambient humidity	35 to 85% RH (No condensation)	
	Vibration resistance	10 to 55 Hz, double amplitude 1.5 mm, 2 hours for each of XYZ axes	
Material		Aluminum die-cast	
Weight (including cable)		Approx. 290 g	

\*1 The value when measuring the KEYENCE standard target (ceramic) in the standard mode

\*2 The value when measuring the KEYENCE standard target (SUS) 4096 times average at the reference distance.

\*3 The value when measuring the KEYENCE standard target (ceramic). When the sampling rate is 20 μs, the value becomes -22 (NEAR side) to -40 mm (NEAR side) at the time of the diffuse reflection, and -22 (NEAR side) to -39 mm (NEAR side) at the time of the regular reflection.





### ■ LK-G157H/LK-G152H

Model		LK-G157H/LK-G152H	
Setting mode		Diffuse reflection	Regular reflection
Reference distance		150 mm	147.5 mm
Measurement range *3		±40 mm	±39 mm
Light source		Red semiconductor laser	
		Wavelength	650 nm (visible light) class 3R (IEC60825-1) class III a (CDRH)
		Output	0.95 mW max.
Spot diameter (at reference distance)		About 120 x 1700 μm (G157H) About ø120 μm (G152H)	
Linearity*1		±0.05% of F.S. (F.S. = ±40 mm)	
Resolution power *2		0.6 μm	
Sampling rate		20/50/100/200/500/1000 μs (Selectable among six steps)	
LED indication		Near the center of measurement range: Lights in green Within the measurement range: Lights in orange Outside the measurement range: Flashes in orange	
Temperature characteristics		0.01% of F.S./°C (F.S. = ±40 mm)	
Environmental resistance	Enclosure rating	IP67 (IEC60529)	
	Operating ambient light	Incandescent lamp or fluorescent lamp: 5000 lux max.	
	Operating ambient temperature	0 to +50 °C	
	Operating ambient humidity	35 to 85% RH (No condensation)	
	Vibration resistance	10 to 55 Hz, double amplitude 1.5 mm, 2 hours for each of XYZ axes	
Material		Aluminum die-cast	
Weight (including cable)		Approx. 290 g	

\*1 The value when measuring the KEYENCE standard target (ceramic) in the standard mode

\*2 The value when measuring the KEYENCE standard target (SUS) 4096 times average at the reference distance.

\*3 The value when measuring the KEYENCE standard target (ceramic). When the sampling rate is 20 μs, the value becomes -22 (NEAR side) to -40 mm (NEAR side) at the time of the diffuse reflection, and +22 (NEAR side) to -39 mm (NEAR side) at the time of the regular reflection.

**Specifications of the Head-to-Controller Cable**

Model	LK-GC2	LK-GC5	LK-GC10	LK-GC30
Cable length	2 m	5 m	10 m	30 m
Weight	Approx. 200 g	Approx. 400 g	Approx. 750 g	Approx. 2000 g

**Status Table**

		Display Panel		Output			Input		RS-232C	USB
		Measurement value	Comparator	Analog voltage (Analog current)	ALARM (N.C.)	Comparator	Binary	TIMING RESET P1/P2/P3		
Measurement mode	Normal	Measurement result	Comparator result	Voltage (current) corresponding to the measurement value	ON	Comparator result	Measurement value	Valid	Valid	Measurement value display/Received light waveform display/ Statistics operation /Data storage operation
	Over range at positive (+) side	FFFFFF	HI	+10.8 V (20.64 mA)	ON	HI	1048575 (0x0FFF FF)	Invalid		
	Over range at negative (-) side	FFFFFF	LO	-10.8 V (3.36 mA)		LO	-1048576 (0x1000 00)			
	Alarm	Dur- ing hold	HOLD			HOLD		Valid		
		Dur- ing alarm	FFFFFF	LO	-10.8 V (3.36 mA)	OFF	LO		-1048576 (0x1000 00)	
	Comparator standby	-----	All OFF		ON	All OFF				
	During RESET processing									
	Dark/Bright		Enters the alarm state.							

6

		Display Panel		Output			Input		RS-232C	USB	
		Measurement value	Comparator	Analog voltage (Analog current)	ALARM (N.C.)	Comparator	Binary	TIMING RESET P1/P2/P3			ZERO
Setting mode		Setting item	Depending on setting	HOLD	HOLD	HOLD	HOLD	Invalid	Invalid	Error	Error
Communication mode	RS-232C communication	--COM--	All OFF	-10.8V (3.36 mA)	OFF	All OFF	-1048576 (0x100000)			Change parameter command	Setting data transmission
	USB communication										
Error		Error indication		-10.8V (3.36 mA)	OFF	All OFF	-1048576 (0x100000)				Error
When power is turned on		None		-10.8V or less (3.36 mA or less)	OFF		0 (0x000000)				

- \* ON/OFF indicates the ON/OFF status of the NPN or PNP open-collector output.
- \* Valid/Invalid indicates the validity/invalidity of input.
- \* HOLD represents the state in which the normal value immediately before is being held.
- \* The RESET processing is performed after the mode is changed to the measurement mode, program number is changed, auto-zero processing is completed, and RESET input is accepted.
- \* USB indicates the communication using the Setup support software "LK-Navigator".
- \* The setting mode indicates the state where setting is performed by key operations on the display panel.
- \* The communication mode indicates the status where setting is performed via RS-232C or USB communication. RS-232C and USB cannot be used at the same time.
- \* Moving to the communication mode and returning to the measurement mode are performed automatically on the Setup support software "LK-Navigator".
- \* Using RS-232C and USB at the same time in the measurement mode lowers the response speed.
- \* The comparator output is issued when the comparator output format is set to normal.

## Response Delay Time

### ■ Measurement response time

This is the period of time until the unit recognizes the change in the target and outputs the signal. This is calculated by the following formula.

- Measurement response time = measurement average time + refresh rate + internal processing time ( $T6 \times 4$ )

☞ Refer to "Timing Details" (page 4-16) for the measurement average time, refresh rate ( $T5$ ), and sampling rate ( $T6$ ).

### ■ Power ON reset time

This is the period of time until measurement starts after turning on the power.

- Power ON reset time = approx. 5 sec.

# 6

## Outside Dimensions

Unit (mm)

### ■ Controller

LK-G3001V/LK-G3001VP

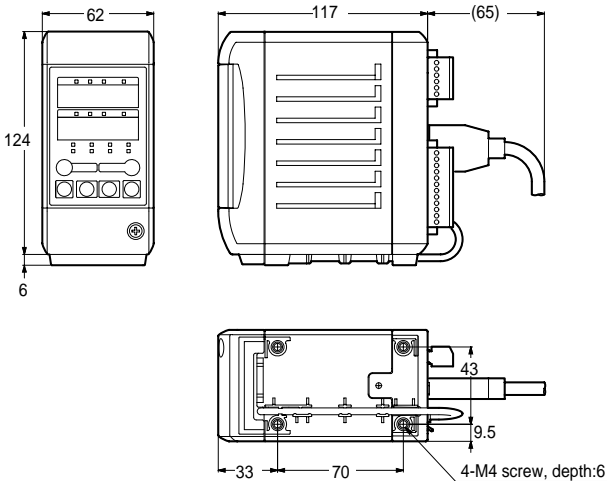

LK-G3001/LK-G3001P

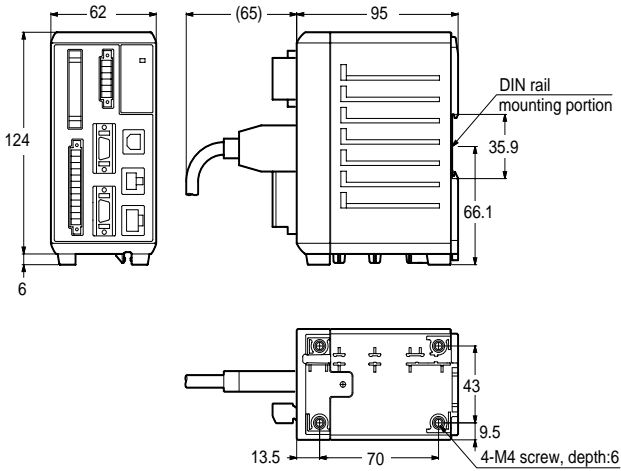

6

LK-GD500

Panel cutout

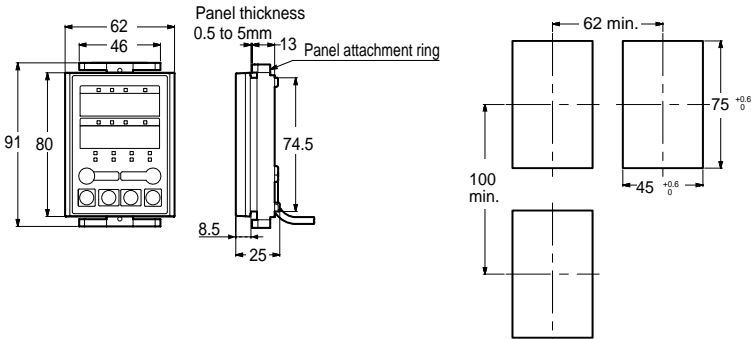

■ Head

- LK-G35/LK-G35H/LK-G30/LK-G30H
- LK-G37/LK-G37H/LK-G32/LK-G32H

Diffuse reflection setup

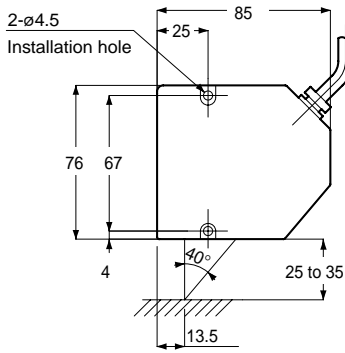

Regular reflection setup

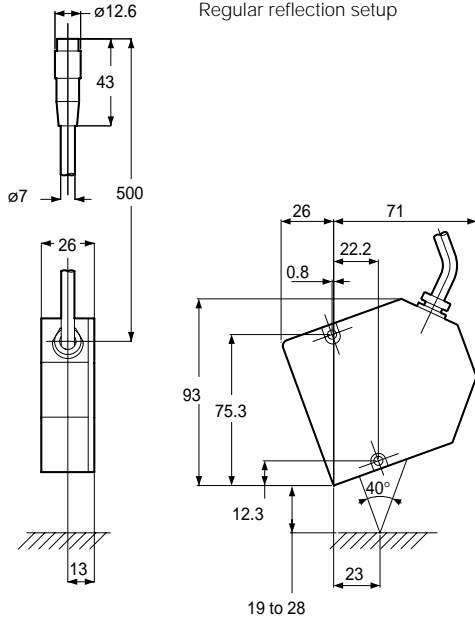

6

- LK-G15/LK-G10
- LK-G15H/LK-G10H

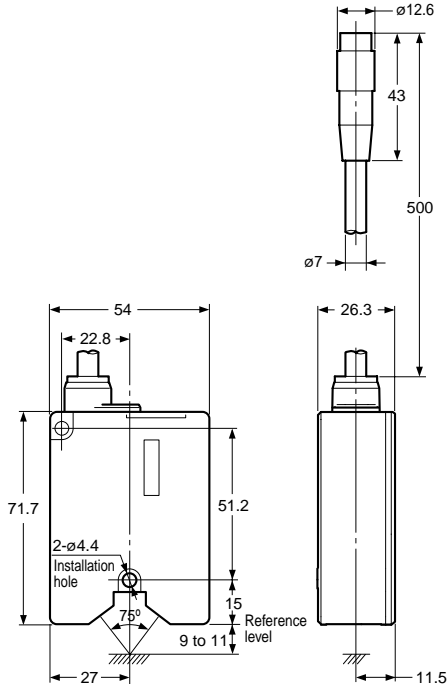

## 6 Specifications of the LK-G Series

- LK-G155/LK-G150
- LK-G155H/LK-G150H

Diffuse reflection setup

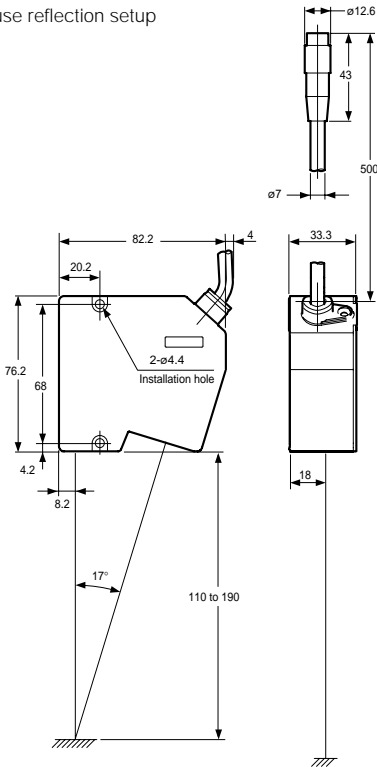

Regular reflection setup

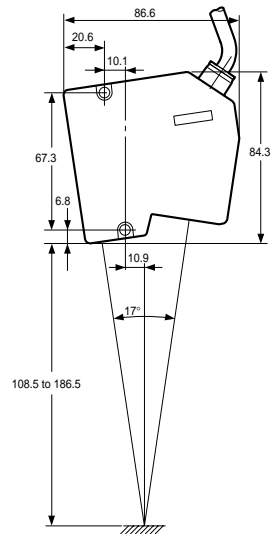

6

### ■ Controller-to-head cable

#### LK-GC2/LK-GC5/LK-GC10/LK-GC30

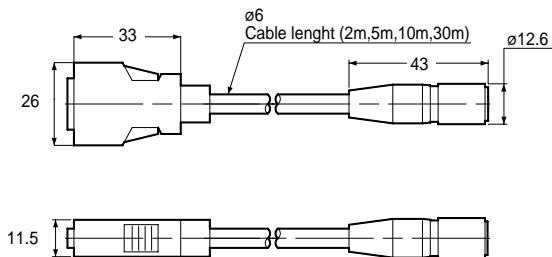



# Characteristics

## Spot Dimension

■ LK-G35/LK-G37

■ LK-G35H/LK-G37H

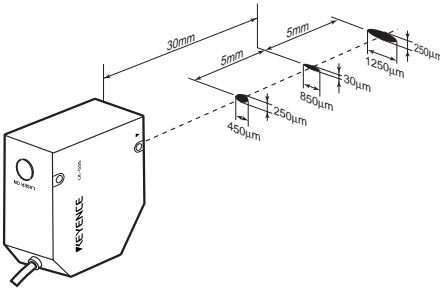

■ LK-G30/LK-G32

■ LK-G30H/LK-G32H

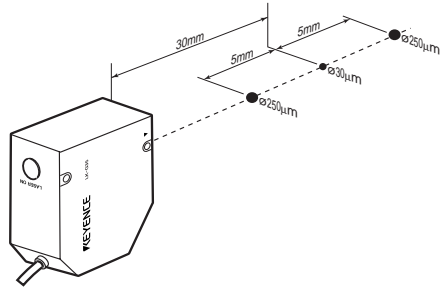

■ LK-G15/LK-G15H

■ LK-G10/LK-G10H

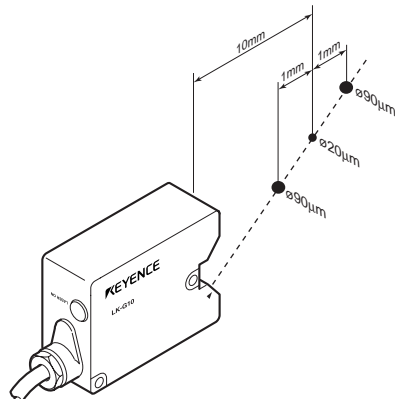
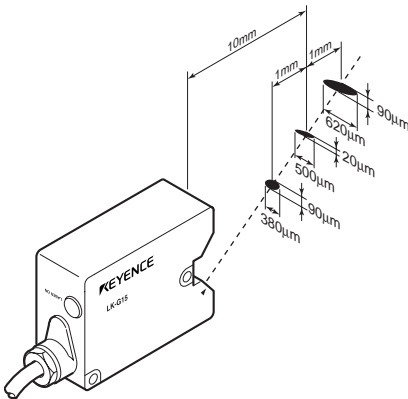

■ LK-G155/LK-G157

■ LK-G155H/LK-G157H

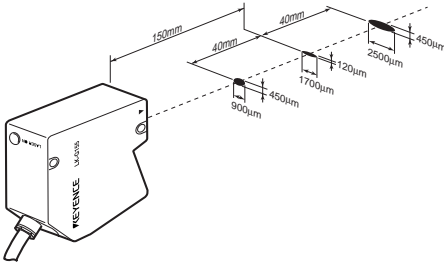

■ LK-G150/LK-G152

■ LK-G150H/LK-G152H

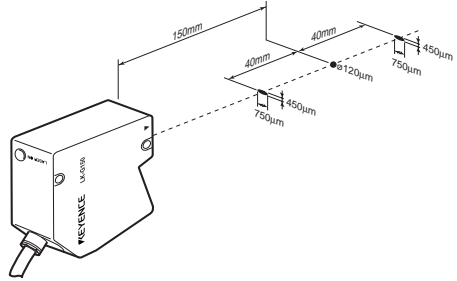

**Mutual Interference**

6

No interference occurs if the beam spot of another sensor is out of the shaded area in the figure.

■ LK-G30/LK-G35/LK-G37/LK-G32

■ LK-G30H/LK-G35H/LK-G37H/LK-G32H

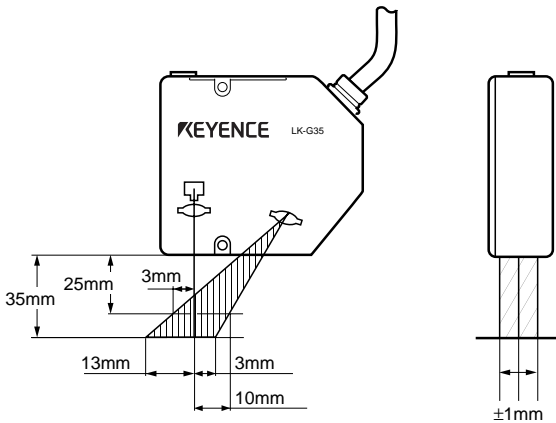

■ LK-G155/LK-G150

■ LK-G155H/LK-G150H

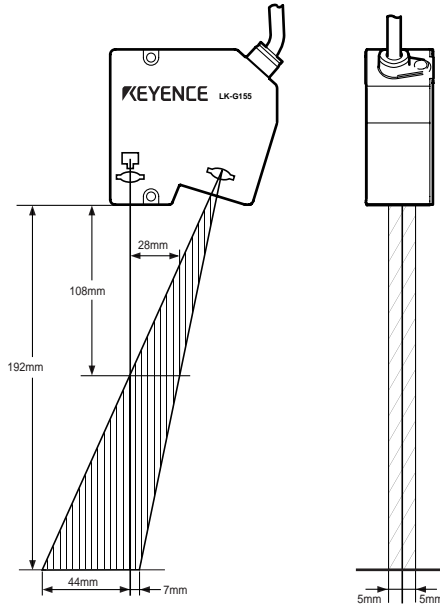

MEMO

---

# Appendices

Troubleshooting .....	A-2
Error Messages .....	A-5
List of Optional Products .....	A-6
Index.....	A-8

# Troubleshooting

This section describes the possible problems and their solutions for LK-G Series operation.

Symptom	Checking content	Remedy
Nothing is displayed on the monitor display.	Are the controller and the display panel cable of the display panel properly connected? Is the power cable properly connected?	Connect the power cable and display panel cable properly. ( <a href="#">□</a> page 1-6)
	Is the ECO mode turned on?	Change the setting as required. ( <a href="#">□</a> page 3-54)
Error message is displayed.	–	Address the problems according to the respective messages displayed on the screen. ( <a href="#">□</a> A -5)
The measured value is not displayed.	Is the measurement target placed within the measurement range?	Place the measurement target within the measurement range. ( <a href="#">□</a> page 1-8)
	Is the head setting properly set?	Set it up properly. ( <a href="#">□</a> page 3-3)
	Does the cover glass have dust or dirt on it?	Remove the dust and dirt. ( <a href="#">□</a> page 1-7)
	Does the cover glass have flaw or crack?	Replacement of the cover glass is required. Because this replacement requires KEYENCE repair service, contact your nearest Sales Office.
	Is the timing control properly set according to the measurement mode?	Set the timing control according to the measurement mode. ( <a href="#">□</a> page 3-41)
	Does the unit have condensation?	Install the unit in the proper operating environment. ( <a href="#">□</a> page 2)
The laser is not emitted.	Is the head-to-controller cable properly connected? Is the power cable properly connected?	Connect the head-to-controller cable and the power cable properly. ( <a href="#">□</a> page 1-16)
	Are the laser remote interlock input and the LASER OFF input inputted properly?	Check wiring connections. ( <a href="#">□</a> page 5)

Symptom	Checking content	Remedy
Displayed measurement values fluctuate.	Is the number of times for averaging properly set?	Set the number of times for averaging properly. (☐ page 3-22)
	Does the cover glass have dust or dirt on it?	Remove the dust and dirt. (☐ page 1-7)
	Does the cover glass have flaw or crack?	Replacement of the cover glass is required. Because this replacement requires KEYENCE repair service, contact your nearest Sales Office.
	Does the ambient operation conditions have splash of water or oil?	Remove the splash by air purging or the like.
	Is there another LK-G sensor head nearby creating mutual interference?	Use the mutual interference prevention function or the LASER OFF function. (☐ page 3-40) Change the mounting position of the sensor head.
	Is there strong extraneous light?	Shield the extraneous light.
	Does the measurement target or the sensor head vibrate?	Take appropriate countermeasures such as protecting vibration.
Displayed measurement values deviate.	Is the head setting properly set?	Check head settings. (☐ page 3-3)
	Is the measurement target slanted or displaced?	Place the measurement target within the measurement range (☐ page 1-8)
	Is the proper calibration value set?	Perform the calibration setting again. (☐ page 3-20)
Cannot change the program No.	Does the ambient operating temperature significantly change?	Keep the ambient operating temperature constant. (☐ page 2)
	Is the program selection properly set?	Set the program selection according to the program change method. (☐ page 3-50)
	Is keylock set to ON?	Set the keylock to OFF. (☐ page 3-53)
Comparator output cannot be outputted properly.	Is the setting mode or the communication mode turned on?	Change the program setting mode to the measurement mode.
	Is the unit properly wired?	Check the output circuit and wiring, and connect properly.
	Is the tolerance properly set?	Perform the tolerance setting again. (☐ page 2-3)
Comparator output form properly set?	Is the comparator output form properly set?	Set it up properly. (☐ page 3-42)

Symptom	Checking content	Remedy
Analog output cannot be outputted properly.	Is the unit properly wired?	Check the wiring and connect properly.
	Does the voltage exceed + 10.8 V or lower -10.8V?	Set the analog scaling properly according to the measurement value. ( <a href="#">□</a> page 3-43)
	Is an oscilloscope or a high-speed A/D board used?	The resolution may decrease if these devices are used. Change the analog scaling so that the effect should be minimized.
Binary output cannot be outputted properly.	Is the unit properly wired?	Check the output circuit and wiring, and connect properly.
	Is the logic properly set?	Negative logic is used in output.
	Is the import timing properly set?	Use strobe output to enable importing in a proper timing. ( <a href="#">□</a> page 4-14)
	Is the OUT1/OUT2 SEL input inputted properly?	Input it correctly. ( <a href="#">□</a> page 4-6)
Cannot communicate via the RS-232C.	Is the communication cable properly connected?	Connect the communication cable properly. ( <a href="#">□</a> page 5-2)
	Does the type of the communication cable conform to the specifications?	Check the connection of the communication cable. ( <a href="#">□</a> page 5-2)
	Are the communication specifications properly set?	Set the communication specifications of the LK-G Series as those of the external devices. ( <a href="#">□</a> page 5-2)
	Is the appropriate communication program used?	Check whether the command and the delimiter is properly sent or received. (page 5-5 <a href="#">□</a> )
	Is the setting properly set according to the communication method or external devices?	Set the auto transmission properly. ( <a href="#">□</a> page 3-49)
The operation key does not work.	Is the display panel properly connected?	Connect the display panel properly. ( <a href="#">□</a> page 1-16)
	Is keylock set to ON?	Set the keylock to OFF. ( <a href="#">□</a> page 3-53)



---

# Error Messages

The list of error messages displayed in the LK-G Series and their remedies is shown below.



Display	Error description	Remedy
<i>Err-0</i>	Head connection error	Check the head connection.
<i>Err-1</i>	Head-A error	
<i>Err-2</i>	Head-B error	
<i>Err-3</i>	Head-A/B error	
<i>Err-4</i>	Controller error	Contact your nearest KEYENCE Office.
<i>Err-5</i>	Display panel error	Check the connection of the display panel cable.
<i>Err-6</i>	SRAM Sum error	Restore the power or perform initialization.
<i>Err-7</i>	Numerical value input error	Cancel the error with the [ENT] key and set the specifications again.

\* If you cannot resume the LK-G Series after executing the above remedies, contact your nearest KEYENCE Office.

# List of Optional Products

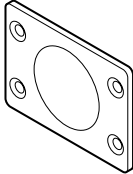
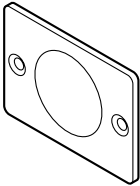
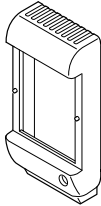
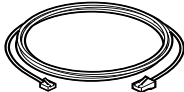
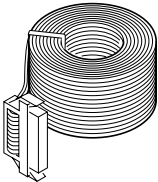
These are the optional products supported by the LK-G Series.

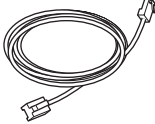
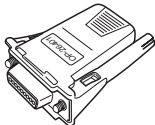
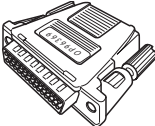
Name		Model	Appearance	Description
ND filter		LK-F1 (for LK-G3*)		Used when the mirror surface is measured at a mirror reflection setup.
		LK-F2 (for LK-G15*)		
Display panel fixing case		OP-51653		Used when combining the display panel (LK-GD500) and the controller (LK-G3001/LK-G3001P).
Display panel cable	30 cm	OP-51654		The connection cable for the display panel (LK-GD500) and the controller (LK-G3001/LK-G3001P).
	3 m	OP-51655		
	10 m	OP-51656		
Expansion panel connector cable (3 m)		OP-51657		The cable for the expansion connector (3 m).

Name	Model	Appearance	Description
RS-232C cable	OP-96368		The communication cable for RS-232C (2.5 m)
Conversion adaptor for RS-232C	OP-26401		Conversion adaptor for the D-sub 9-pin connector. Used in combination with OP-96368.
Conversion adaptor for RS-233C	OP-96369		Conversion adaptor for the D-sub 25-pin connector. Use in the combination with OP-96369.
USB cable	OP-35331		The cable for the USB connection (3 m).

---

# Index

## Alpha-numerical

- 12-pin I/O terminal block ..... 1-7, 4-2
- 6-pin I/O terminal block ..... 1-7, 4-4

## A

- ABLE calibration function ..... 3-10
- ABLE function ..... 3-5
- Alarm output ..... 4-7
- Alarm process ..... 3-8
- Analog current output ..... 4-11
- Analog monitor output ..... 4-4
- Analog output scaling ..... 3-34
- Analog voltage output ..... 4-10
- Analog-through ..... 3-36
- ASCII code ..... 5-24
- Auto offset function ..... 2-6, 3-32
- Auto-zero function ..... 2-6, 3-32
- Auto-zero input ..... 4-7
- Average hold ..... 3-25, 3-28, 4-12
- Averaging function ..... 3-22

## B

- Binary Output ..... 4-5, 4-8
- Bottom hold ..... 3-25, 3-28, 4-12

## C

- Calculation between heads ..... 3-18
- CE Marking ..... 3
- Change parameter command ..... 5-13
- Characteristics ..... 6-10
- Check parameter command format ..... 5-20
- Combining the separate type controller ..... 1-17
- Command format ..... 5-5
- Common functions ..... 3-37
- Common settings ..... 1-22
- Communication mode ..... 5-3

- Communication Specifications ..... 5-2
- Comparator output ..... 4-7
- Comparator standby ..... 2-3
- Conditions of the measurement value output ..... 3-13
- Connection ..... 1-19
  - Connecting the terminal block ..... 1-20
  - Connecting the power ..... 1-20
  - Connecting the display panel ..... 1-20
  - Connecting the head ..... 1-19
- Copying and initializing of the program ..... 3-51
- Corrective action for noise ..... 2

## D

- Data Storage Function ..... 3-44
- Decimal point position ..... 3-33
- Diffuse reflection mode ..... 1-8, 3-12
- Display panel ..... 1-6
- Display panel connector ..... 1-7
- Dual display ..... 2-2

## E

- Eco mode ..... 3-54
- Environment Setting Screens ..... 3-48
- Environment Settings ..... 1-22, 3-46
- Error Messages ..... A-5
- Expansion connector ..... 1-7, 4-5
- External synchronization ..... 5-22
- External Timing Input ..... 3-41

## F

- Filter function ..... 3-22
- Function of high-pass filter ..... 3-23
- Function of the Tolerance Settings ..... 2-3

## G

- GO ..... 2-3

---

## H

Head .....	1-4
Head connector .....	1-7
Head Settings .....	1-22, 3-3
Height-difference measurement .....	3-18
HIGH .....	2-3
Hold Function .....	3-25
Hysteresis .....	2-5

## I

Identifying Part Names and Functions.....	1-6
Inadequate light intensity .....	3-8
Initialization .....	1-23
Input and output signals for measurement control .....	4-7
Input response time .....	4-16
Input/Output Terminals .....	4-2
Installation environment .....	2
Installing the controller.....	1-14
Installing the single unit type controller .....	1-15
Installing the separate type controller .....	1-15
Installing the head .....	1-9

## L

Laser beam damping terminal .....	6
Laser emission LED .....	1-7, 1-8
Laser remote interlock terminal .....	6
List of Default Values and Setting Ranges (Common Settings) ...	3-37
List of Default Values and Setting Ranges (Environment Settings) .....	3-47
List of Default Values and Setting Ranges (Head Settings) .....	3-3
List of Default Values and Setting Ranges (OUT Settings) .....	3-15
List of Functions and Function Nos. (Head settings) .....	3-3
List of Functions and Function Nos. (Environment settings) .....	3-46

List of Functions and Function Nos. (Common function) .....	3-37
List of Functions and Function Nos. (OUT settings).....	3-13
List of Optional Products.....	A-6
List of the common function setting screens .....	3-38
List of the Head Setting Screens .....	3-4
List of the OUT setting screens.....	3-16
LOW .....	2-3

## M

Measurement average time .....	4-16
Measurement Control Command Format .....	5-8
Measurement mode .....	3-25
Measurement mode setting .....	3-7
Measurement value format .....	5-6
Minimum display unit .....	3-33
Minimum input time .....	4-17
Mirror reflection .....	1-8, 3-12
Mode change command .....	5-7
Mounting mode setting .....	3-12
Multi-reflective object .....	3-7
Mutual Interference .....	6-11
Mutual interference prevention function .....	3-40

## N

ND filter attachment .....	1-12
ND filter attachment holes .....	1-8
No-voltage input .....	4-10
Normal mode .....	5-3
Number of digit to be displayed .....	3-33

## O

Offset .....	3-32
Open-collector output .....	4-10, 4-11
Operating ambient temperature .....	2
Operation keys .....	1-6
OUT Settings.....	1-22

Outer dimension .....	6-7
Output form of the tolerance comparator .....	3-42
Output format .....	5-24

## P

Package Contents .....	1-3
Panel lock .....	3-53
Peak hold.....	3-25, 3-28, 4-12
Peak-to-peak hold .....	3-25, 3-28, 4-12
Program Change .....	3-50
Program function .....	2-8
Program No. change time .....	4-17
Program No. switch function .....	2-9
Program No. switch input .....	4-7

## R

Refresh rate .....	4-16
RESET time.....	4-16
Response Delay Time .....	6-7
Returning the LK-Series to the Factory Default Settings .....	1-23
Reference rate.....	4-17
RESET Time.....	4-17
RS-232C .....	5-1
RS-232C communication specifications.....	3-49
RS-232C connector .....	1-7

## S

Sample hold .....	3-25, 3-29, 4-12
Sampling rate .....	3-39
Scaling (Calibration) .....	3-20
Sensor (emitter) .....	1-8
Sensor (receiver) .....	1-8
Separate type controller .....	1-3
Separate Type Display Panel .....	1-4
Separating the Single Unit Type Controller .....	1-16
Setting mode .....	1-22
Setting Procedure of Numerical Values .....	2-4

Setting value format.....	5-6
Single display .....	2-2
Single unit type controller .....	1-3
Specifications .....	6-2
Specifications of the controller .....	6-2
Specifications of the head .....	6-4
Spot diameter .....	6-10
Statistical computation .....	2-10
Status Table .....	6-5
Strobe output time .....	3-43
Switching Modes .....	1-21
Switching the measurement value display .....	2-2
System configuration.....	1-2

## T

Thickness measurement.....	3-18
Timing Chart .....	4-11
Timing synchronization.....	3-41
Tolerance comparator value setting .....	2-3
Translucent object .....	3-7
Transparent object.....	3-7
Transparent object 2.....	3-7
Trigger Condition .....	3-31
Troubleshooting .....	A-2

## U

USB connector .....	1-7
---------------------	-----

## V

Voltage input.....	4-11
--------------------	------

## W

Warning labels.....	7
---------------------	---

---

MEMO

---

MEMO



---

MEMO

**Revision history**

<b>Date of printing</b>	<b>Version</b>	<b>Revision contents</b>
March, 2005	Official release	

## WARRANTIES AND DISCLAIMERS

(1) KEYENCE warrants the Products to be free of defects in materials and workmanship for a period of one (1) year from the date of shipment. If any models or samples were shown to Buyer, such models or samples were used merely to illustrate the general type and quality of the Products and not to represent that the Products would necessarily conform to said models or samples. Any Products found to be defective must be shipped to KEYENCE with all shipping costs paid by Buyer or offered to KEYENCE for inspection and examination. Upon examination by KEYENCE, KEYENCE, at its sole option, will refund the purchase price of, or repair or replace at no charge any Products found to be defective. This warranty does not apply to any defects resulting from any action of Buyer, including but not limited to improper installation, improper interfacing, improper repair, unauthorized modification, misapplication and mishandling, such as exposure to excessive current, heat, coldness, moisture, vibration or outdoors air. Components which wear are not warranted.

(2) KEYENCE is pleased to offer suggestions on the use of its various Products. They are only suggestions, and it is Buyer's responsibility to ascertain the fitness of the Products for Buyer's intended use. KEYENCE will not be responsible for any damages that may result from the use of the Products.

(3) The Products and any samples ("Products/Samples") supplied to Buyer are not to be used internally in humans, for human transportation, as safety devices or fail-safe systems, unless their written specifications state otherwise. Should any Products/Samples be used in such a manner or misused in any way, KEYENCE assumes no responsibility, and additionally Buyer will indemnify KEYENCE and hold KEYENCE harmless from any liability or damage whatsoever arising out of any misuse of the Products/Samples.

(4) OTHER THAN AS STATED HEREIN, THE PRODUCTS/SAMPLES ARE PROVIDED WITH NO OTHER WARRANTIES WHATSOEVER. ALL EXPRESS, IMPLIED, AND STATUTORY WARRANTIES, INCLUDING, WITHOUT LIMITATION, THE WARRANTIES OF MERCHANTABILITY, FITNESS FOR A PARTICULAR PURPOSE, AND NON-INFRINGEMENT OF PROPRIETARY RIGHTS, ARE EXPRESSLY DISCLAIMED. IN NO EVENT SHALL KEYENCE AND ITS AFFILIATED ENTITIES BE LIABLE TO ANY PERSON OR ENTITY FOR ANY DIRECT, INDIRECT, INCIDENTAL, PUNITIVE, SPECIAL OR CONSEQUENTIAL DAMAGES (INCLUDING, WITHOUT LIMITATION, ANY DAMAGES RESULTING FROM LOSS OF USE, BUSINESS INTERRUPTION, LOSS OF INFORMATION, LOSS OR INACCURACY OF DATA, LOSS OF PROFITS, LOSS OF SAVINGS, THE COST OF PROCUREMENT OF SUBSTITUTED GOODS, SERVICES OR TECHNOLOGIES, OR FOR ANY MATTER ARISING OUT OF OR IN CONNECTION WITH THE USE OR INABILITY TO USE THE PRODUCTS, EVEN IF KEYENCE OR ONE OF ITS AFFILIATED ENTITIES WAS ADVISED OF A POSSIBLE THIRD PARTY'S CLAIM FOR DAMAGES OR ANY OTHER CLAIM AGAINST BUYER. In some jurisdictions, some of the foregoing warranty disclaimers or damage limitations may not apply.

**BUYER'S TRANSFER OBLIGATIONS:** If the Products/Samples purchased by Buyer are to be resold or delivered to a third party, Buyer must provide such third party with a copy of this document, all specifications, manuals, catalogs, leaflets and written information provided to Buyer pertaining to the Products/Samples.



**KEYENCE CORPORATION**  
1-3-14, Higashi-Nakajima,  
Higashi-Yodogawa-ku, Osaka,  
533-8555, Japan  
Phone: 81-6-6379-2211  
Fax: 81-6-6379-2131

#### **AFFILIATED COMPANIES**

**KEYENCE CORPORATION OF AMERICA**  
Phone: 201-930-0100 Fax: 201-930-0099

**KEYENCE DEUTSCHLAND GmbH**  
Phone: 06102-36 89-0 Fax: 06102-36 89-10

**KEYENCE (UK) LIMITED**  
Phone: 01908-696900 Fax: 01908-696777

**KEYENCE FRANCE S.A.**  
Phone: 01 56 37 78 00 Fax: 01 56 37 78 01

**KEYENCE ITALIA S.p.A.**  
Phone: 02-6688220 Fax: 02-66825099

**KEYENCE SINGAPORE PTE LTD.**  
Phone: 6392-1011 Fax: 6392-5055

**KEYENCE (MALAYSIA) SDN BHD**  
Phone: 03-2092-2211 Fax: 03-2092-2131

**KEYENCE (THAILAND) CO., LTD.**  
Phone: 02-369-2777 Fax: 02-369-2775

**KEYENCE TAIWAN CO., LTD.**  
Phone: 02-2718-8700 Fax: 02-2718-8711

**KEYENCE (HONG KONG) CO., LTD.**  
Phone: 3104-1010 Fax: 3104-1080

**KEYENCE INTERNATIONAL TRADING  
(SHANGHAI) CO., LTD.**  
Phone: 021-68757500 Fax: 021-68757550

**KOREA KEYENCE CO., LTD.**  
Phone: 02-563-1270 Fax: 02-563-1271

Specifications are subject to change without notice.